

Guide for

Certification of Container Securing Systems



August 2024



GUIDE FOR

...
CERTIFICATION OF CONTAINER SECURING SYSTEMS
AUGUST 2024

**American Bureau of Shipping
Incorporated by Act of Legislature of
the State of New York 1862**

**© 2024 American Bureau of Shipping. All rights reserved.
ABS Plaza
1701 City Plaza Drive
Spring, TX 77389 USA**

Foreword (1 August 2024)

The *Guide for Certification of Container Securing Systems* was first published by ABS with input and advice from industry. When requested by the Owner, ABS will issue certificates for container securing systems which have been constructed and installed according to the requirements of this Guide. However, such a certification is not a classification requirement.

Existing container securing systems which have not been constructed and installed to the requirements of the Guide will, at the request of the Owner, be subjected to a condition survey and plan review for compliance or equivalence with the Guide.

During the years of 2012 ~ 2014, this Guide had gone through a series of revisions and updates reflecting the development in container securing systems.

To meet the industry's demand and service challenge, ABS introduced new requirements and procedures in the July 2016 revision. They are summarized in the following table:

<i>Section</i>	<i>Description of Change</i>
8/3.1, 8/7.7, 8/7.7 TABLE 1	Prototype testing procedures for certifying fully automatic twistlocks are described in these sections.
9/3.9.1 (1 st Para.) & 9/3.9.4	The GM range indicated in 9/3.9.4 is also applicable to container securing manual, not only computer lashing program. As such, the GM range in 9/3.9.4 is moved to 9/3.9.1.
9/3.9.1 (2 nd Para. & table)	It is clarified that for operation in specific voyage trade routes, a minimum of three bays (one from forward bay, one from midship bay and one from aft bay) are sufficient.
Appendix A4	It is clarified that for unrestricted services, the least necessary test cases to be submitted for ABS review are specified.
Appendix A5	The newly developed Appendix A5 offers detailed prototype function test procedure for fully automatic twistlocks. The previous existing Appendix A5 is renumbered to Appendix A6.

The February 2017 revision incorporated the following changes:

<i>Section</i>	<i>Description of Change</i>
2/1	Introduces the fully nonlinear software program "ABS Eagle C-Lash [®] "
2/5.3	Removes definitions of symbols that are not used in the new Subsection 6/5.
3/Table 3, 3/Figure 1	Revises side wall racking force limits and horizontal lashing force on top and bottom corner fittings to be consistent with the limits applied in other similar container securing criteria.
4/Table 2	Revises equivalent elastic modulus of short steel rod lashing assembly (not greater than 5000 mm) for consistency with the limits applied in similar container securing criteria.
5/5.3, 5/Figure 5, 5/Figure 6	Clarifies and states ABS requirements for raised lashing platforms on the basis of the established engineering practices.
6/3.3.1, 6/3.13.4	Clarifies that wind load is applied at maximum roll angle to be consistent with acceleration and that the transverse acceleration and wind forces have same direction only when the minimum vertical acceleration is applied in condition A.
6/3.5.2, 6/3.7	Simplifies the formula for SI and US units.

<i>Section</i>	<i>Description of Change</i>
6/5, 6/FIGURE 4, 6/TABLE 1, 6/FIGURE 5	Considers the twistlock clearance, container rigid body movement and lashing bridge fetch or stiffness.
A4/3	Specifies that onshore calculations are acceptable.

The May 2017 revision deleted the sample calculation in Appendix 1. The December 2017 revision to Subsection 6/5 allowed for alternative analysis procedures that take into account the lashing system nonlinearities to be considered. The May 2018 revision to 6/3.7 removed the provisions for evaluating only Condition A or Condition B, requiring both conditions to be satisfied.

The April 2019 edition expanded 6/7.11.3 TABLE 2 and 6/7.11.3 TABLE 3 to cover transverse accelerations from 0.20g to 0.34g.

The August 2019 revision added an approach for reducing the transverse acceleration for vessels using weather forecast reports to plan Short Voyages.

The April 2021 edition specified when the Condition B flexibility requirement is to be considered. Also, a new Northeast Asia - Australia route was added in Appendix 2.

The December 2021 edition removes the vibration requirement for lashing platforms in 5/5.3.2(g).

The September 2022 edition reinstated the previous detailed linear approach in Subsection 6/5 and added the non-linear procedure for external lashings. Subsection 2/1 was updated to clarify that the **CSC** notation is a prerequisite of the **CLP** and **CLP-V** notations.

The December 2023 edition updated the wind load in 6/3.3.1 to consider wind shielding.

The January 2024 edition added a Reduction Factor for transverse acceleration of the vessel based on a Route Splitting approach. Subsection 2/1 was updated and 6/3.7.5 was added for the requirements of the **CLP-V(PARR)** notation.

The March 2024 edition removed the limitation in Subsection 6/5 that the nonlinear procedure is to be used only for external lashings.

The May 2024 edition added factors for large bilge keels and anti-rolling tanks in the calculation of roll motions in 6/3.5.2(a).

The August 2024 edition specifies that the vertical clearance at safe working load to be used in the lashing calculation is to be indicated on the Type Approval Certificate and clarifies that this value is to be developed from the function test results.

The requirements are based on SI units, and the values shown in U.S. (foot-pound-second) units are derived by numerical conversion.

This Guide does not apply to containers on chassis or trailers stowed aboard vessels.

This Guide becomes effective on the first day of the month of publication.

Users are advised to check periodically on the ABS website www.eagle.org to verify that this version of this Guide is the most current.

We welcome your feedback. Comments or suggestions can be sent electronically by email to rsd@eagle.org.



GUIDE FOR

CERTIFICATION OF CONTAINER SECURING SYSTEMS

CONTENTS

SECTION	1	Scope and Conditions of Certification.....	11
	1	Certification.....	11
	1.1	Process.....	11
	1.3	Certificates and Reports.....	11
	1.5	Representations as to Certification.....	12
	1.7	Scope of Certification.....	12
	3	Suspension and Termination of Certification.....	12
	3.1	Suspension of Certification.....	12
	3.3	Lifting of Suspension.....	13
	3.5	Termination of Certification.....	13
	3.7	Notice of Surveys.....	13
	5	Rules for Certification.....	13
	5.1	Scope.....	13
	5.3	Alternatives.....	13
	5.5	Effective Date of Change of Requirement.....	13
	5.7	ABS Type Approval Program.....	14
	7	Other Regulations	18
	7.1	International and Other Regulations.....	18
	7.3	Governmental Regulations.....	18
	7.5	Other Rules.....	18
	9	Submission of Plans	18
	11	Notification and Availability for Survey.....	19
	13	Units.....	19
	15	Fees.....	19
	17	Disagreement.....	19
	17.1	Rules and Guides.....	19
	17.3	Surveyor.....	19
	19	Limitation of Liability.....	19
	21	Hold Harmless.....	20
	23	Time Bar to Legal Action.....	20
	25	Arbitration.....	20

	TABLE 1	Certification - Container Securing Devices.....	14
SECTION	2	General.....	21
	1	Scope.....	21
	3	Submission of Plans and Design Data.....	22
	3.1	General (2012).....	22
	3.3	Information to Be Submitted (2012).....	22
	5	Definitions and Symbols.....	22
	5.1	Definitions.....	23
	5.3	Symbols.....	25
	7	Descriptions of Container Stowage Locations.....	26
	FIGURE 1	ISO Bay Numbering Scheme	27
	FIGURE 2	ISO Stack/Row and Tier Numbering Scheme.....	28
SECTION	3	Container Characteristics.....	29
	1	General.....	29
	3	Dimensions.....	29
	5	Permissible Container Loads and Strength Ratings.....	31
	5.1	Permissible Forces on Corner Fittings.....	33
	5.3	Containers with Stacking Posts Offset from the End Walls.....	34
	7	Racking Spring Constants.....	34
	7.1	Specialty Containers.....	34
	7.3	Containers with One or Both Doors Removed.....	35
	9	Container Strength Tests.....	35
	TABLE 1A	External Container Dimensions and Tolerances SI & MKS Units	29
	TABLE 1B	External Container Dimensions and Tolerances US Units ..	30
	TABLE 2A	Container Corner Fitting Dimensions and Tolerances SI & MKS Units.....	30
	TABLE 2B	Container Corner Fitting Dimensions and Tolerances US Units.....	31
	TABLE 3	Design Loads on Containers and Container Fittings (<i>1 February 2017</i>).....	31
	TABLE 4	Racking Spring Constant, K_C and K_{CL}	34
	FIGURE 1	Design Loads for ISO 20-ft and 40-ft Containers (<i>1 February 2017</i>).....	33
SECTION	4	Securing Devices.....	36
	1	General.....	36
	3	Loose Fittings.....	36

	3.1	Twistlocks, Stackers, and Other Container Connectors..	36
	3.3	Lashing Assemblies.....	38
	3.5	Stiffness of Loose Fittings.....	39
5		Fixed Fittings.....	41
	5.1	Foundations and Base Plates.....	41
	5.3	Twistlock Foundations (Deck Sockets or Base Sockets).....	41
	5.5	Lashing Plates and D-Rings.....	42
7		Strength Ratings and Factors of Safety.....	42
	7.1	Safety Factors for Securing Devices.....	43
	7.3	Strength Ratings for Securing Devices.....	43
	7.5	Strength of Weldments for Fixed Securing Devices.....	43
	TABLE 1	Area of Lashing Component, A_{ℓ}	40
	TABLE 2	Equivalent Elastic Modulus, E_{ℓ} (1 February 2017).....	40
	TABLE 3	Safety Factors for Securing Fittings.....	43
	TABLE 4	Typical Design Load for Container Securing Fittings.....	44
	FIGURE 1	Sample Stacker.....	37
	FIGURE 2	Sample Lock Fittings	37
	FIGURE 3	Sample Bridge Fittings and Strut.....	38
	FIGURE 4	Sample Foundation and Guide Fitting.....	41
	FIGURE 5	Sample Twistlock Foundations or “Base Sockets”.....	41
	FIGURE 6	Sample Lashing Points.....	42
SECTION	5	Container Securing Arrangements.....	46
	1	General.....	46
	3	Stacks Secured Only with Lock Fittings.....	46
	5	Flexible Securing Systems (Lashings).....	46
	5.1	Typical Lashing Arrangements.....	46
	5.3	Raised Lashing Platforms (1 February 2017).....	50
	5.5	Containers Secured with Different Lashings Systems at Each End.....	55
	5.7	Relative Movement of Support or Securing Points.....	55
	7	Cell Guides.....	55
	7.1	Design Considerations.....	56
	7.3	Container Cell Guides at Only One End.....	57
	9	Systems Combining Flexible and Rigid Elements.....	58
	11	Other Fixed or Rigid Securing Systems.....	58
	13	Block Stowage of Containers.....	59
	15	Stacks of Mixed Length and Width.....	59
	FIGURE 1	Typical Lashing Arrangements.....	48

FIGURE 2	Combined Lashing Systems.....	49
FIGURE 3	Side Lashing System.....	49
FIGURE 4	Raised Lashing Platform.....	50
FIGURE 5	Procedural Flowchart for Design Load Determination (<i>1 February 2017</i>).....	53
FIGURE 6	Lashing Platform Structural Design Loads as Percentages of Lashing Rod SWL (<i>1 February 2017</i>).....	54
FIGURE 7	Typical Hold Cell Guide Arrangement	56
FIGURE 8	20-ft Container Stowage in 40-ft Cell Guides.....	58

SECTION	6	Securing System Design Principles.....	61
	1	General.....	61
	3	Design Loads	61
	3.1	General.....	61
	3.3	Wind Loads.....	61
	3.5	Design Ship Motions.....	63
	3.7	Accelerations.....	66
	3.9	Optional Direct Calculation of Accelerations (<i>1 April 2014</i>).....	72
	3.11	Mass Distribution and Center of Gravity of Containers....	72
	3.13	Distribution of Loads Acting on Containers.....	72
	5	Analysis Procedure for Container Securing System	74
	5.1	General.....	75
	5.3	Container End Wall Racking.....	75
	5.5	Lashing Tension.....	77
	5.7	Lashing Force on Container Corner Fitting.....	83
	5.9	Corner Post Compression.....	83
	5.11	Corner Post Tension.....	87
	5.13	Adjustments to Linear Results for External and Vertical Lashings.....	88
	7	Design Application.....	90
	7.1	General.....	90
	7.3	Stacks Secured with Twistlocks Only.....	90
	7.5	Stacks Secured with Cross Lashing or Side Lashing Systems.....	90
	7.7	Stacks Secured with Vertical Lashings.....	90
	7.9	Container Stacks within Cell Guides.....	91
	7.11	Carriage of 20-ft Containers in Cell Guides Designed for 40-ft Containers.....	91
	7.13	Other Rigid Securing Systems.....	96
	7.15	Combining Securing Systems.....	96
	7.17	Block Stowage.....	96
	9	Acceptance Criteria.....	97
	9.1	General.....	97
	9.3	Containers.....	97

	9.5	Securing Fittings.....	97
	9.7	Fixed Cell Guides, Shoring, Buttresses and Other Rigid Supports.....	97
11		Design Considerations for Hull Structure.....	97
	11.1	Design Loads.....	97
	11.3	Allowable Stresses.....	97
TABLE 1		Lashing Equations for Typical Arrangements.....	82
TABLE 2		Permissible Average Weight of 20-ft Containers Stowed in 40-ft Cell Guides (without 40-ft Container Topping).....	93
TABLE 3		Permissible Average Weight of 20-ft Containers Stowed in 40-ft Cell Guides (with 40-ft Container Topping).....	94
FIGURE 1		Flowchart for F_w determination.....	62
FIGURE 2		Container Stack Arrangements and F_w Values.....	63
FIGURE 3		Forces Due to Gravity and Ship Motions.....	67
FIGURE 4		Distribution of Force Factor k_3	68
FIGURE 5		Application of Forces to Ends and Sides of Container.....	73
FIGURE 6		Racking Force without Lashing Restraint (3-tier High Stack).....	76
FIGURE 7		Racking Force with Lashing Restraint (3-tier High Double Lashed Stack).....	77
FIGURE 8		Lashing Angle and Lashing Length.....	77
FIGURE 9		Horizontal Displacement (3-tier High Double Lashed Stack).....	79
FIGURE 10		Lashing Elongation at First Tier Container.....	80
FIGURE 11		Corner Post Compression.....	84
FIGURE 12		Distances to Forces Acting on Containers.....	86
FIGURE 13		Corner Post Tension.....	87
FIGURE 14		General Steps of Adjustment.....	89
FIGURE 15		Non-Linear Lashing Analysis.....	90
SECTION	7	Materials and Welding.....	98
	1	General.....	98
	3	Materials.....	98
	3.1	Rolled Steel.....	98
	3.3	Cast and Forged Securing Components.....	98
	3.5	Chain.....	98
	5	Welding.....	98
	7	Impact Properties.....	99
SECTION	8	Testing, Inspection, and Approval of Securing Devices.....	100
	1	Drawings.....	100
	3	Testing.....	100

	3.1	Prototype Testing (1 July 2016).....	100
	3.3	Production Testing.....	100
5		Marking of Securing Devices.....	101
7		Type Approval.....	101
	7.1	General.....	101
	7.3	Product Design Assessment (PDA) Review.....	101
	7.5	Quality Assurance.....	101
	7.7	Type Approval Certificate.....	102
	TABLE 1	Required Prototype Tests (1 July 2016).....	102
SECTION	9	Container Securing Manuals.....	104
	1	General.....	104
	3	Contents of the Container Securing Manual.....	104
	3.1	General.....	104
	3.3	Container Stowage Arrangements.....	105
	3.5	Fixed and Portable Securing Components.....	105
	3.7	Diagrams of Approved Container Securing Systems....	106
	3.9	Presentation of Permissible Container Stack Weights..	107
	FIGURE 1	Sample Stack Securing Diagram	107
SECTION	10	Surveys.....	111
	1	Initial Installation Survey.....	111
	3	Container Securing Manual.....	111
	5	Maintenance in Service.....	111
APPENDIX	1	Shipboard Safety Systems.....	112
	1	General.....	112
	3	Design.....	112
	5	Arrangement.....	112
	7	Operation.....	112
	9	Anchorage	112
APPENDIX	2	Maps of Route-Specific Trades	114
	1	Asia – Europe.....	114
	2	Pacific – Atlantic.....	115
	3	North Pacific.....	115
	4	North Sea – Mediterranean.....	116
	5	North Atlantic.....	117
	6	Asia – South America (West Coast).....	117
	7	South America (East Coast) – Africa.....	118
	8	Africa – East Asia.....	118

	9	Europe (Rotterdam) – Africa.....	119
	10	Europe (Rotterdam) – South America (Brazil).....	120
	11	US (NYC) – South America (Brazil).....	121
	12	Northeast Asia - Australia.....	122
APPENDIX	3	Onboard Computers for Lashing Calculations (1 April 2014).....	123
	1	General	123
	3	General Requirements	123
	5	Plans and Data	124
APPENDIX	4	Prototype Function Test Procedure for Fully Automatic Twistlocks (1 July 2016).....	125
	1	Documentation.....	125
	1.1	Design Information.....	125
	3	Test Jig Configuration.....	126
	5	Corner Castings.....	126
	7	Prototype Load Test.....	127
	7.1	Position A and B.....	127
	7.3	Loads and Their Sequences.....	128
	TABLE 1	Vertical Clearance for Lashing Calculation.....	130
	FIGURE 1	Test Jig (1 July 2016).....	126
	FIGURE 2	ISO Corner Casting (1 July 2016).....	127
	FIGURE 3	Container Movement and Forces Position A and B (1 July 2016).....	128
APPENDIX	5	References (1 July 2016).....	131

1 Certification

1.1 Process

The term certification, as used herein, indicates that the initial installation of container securing systems aboard vessels have been designed, constructed, installed, and surveyed in compliance with this Guide, existing Rules and Guides or other acceptable standards.

The certification process consists of:

- a)* The development of Rules, Guides, standards, and other criteria for the design, construction, and initial installation of container securing systems;
- b)* The review of the design and survey during initial installation to verify compliance with such Rules, Guides, standards, or other criteria;
- c)* The assignment and registration of certification when such compliance has been verified.

The Rules, Guides, and standards are developed by the ABS staff and passed upon by committees made up of naval architects, ocean and marine engineers, shipbuilders, engine builders, steel makers, process engineers and by other technical, operating and scientific personnel associated with the worldwide maritime and container industry. Theoretical research and development, established engineering disciplines, as well as satisfactory service experience are utilized in their development and promulgation. ABS and its committees can act only upon such theoretical and practical considerations in developing Rules and standards.

For certification, the container securing systems are to comply with the applicable requirements of this Guide and all applicable Rules.

1.3 Certificates and Reports

Review of design documentation and surveys during construction are conducted by ABS to verify to itself and its committees that an item of material or equipment is in compliance with this Guide and is to the satisfaction of the attending Surveyor. All reports and certificates are issued solely for the use of ABS, its committees, its clients, and other authorized entities.

An approved copy of the container securing manual, copies of the prototype and production test reports for the securing gear, and a copy of the Initial Installation Survey Certificate are to be carried aboard the vessel for use by the vessel's personnel.

1.5 Representations as to Certification

Certification is a representation by ABS as to the structural and mechanical fitness for a particular use or service, in accordance with its Rules, Guides, and standards. The Rules and Guides of the American Bureau of Shipping are not meant as a substitute for the independent judgment of professional designers, naval architects, marine engineers, Owners, operators, masters and crew, nor as a substitute for the quality control procedures of ship and platform builders, engine builders, steel makers, suppliers, manufacturers and sellers of marine vessels, materials, system components, machinery or equipment. ABS, being a technical society, can only act through Surveyors or others who are believed by it to be skilled and competent.

ABS represents solely to the Container Securing Systems manufacturer or other clients of ABS that when certifying, it will use due diligence in the development of Rules, Guides, and standards, and in using normally applied testing standards, procedures and techniques as called for by the Rules, Guides, standards or other criteria of ABS. ABS further represents to the Owner or other clients of ABS that its certificates and reports evidence compliance only with one or more of the Rules, Guides, standards, or other criteria of ABS, in accordance with the terms of such certificate or report. Under no circumstances whatsoever are these representations to be deemed to relate to any third party.

The user of this document is responsible for ensuring compliance with all applicable laws, regulations, and other governmental directives and orders related to a vessel, its machinery and equipment, or their operation. Nothing contained in any Rule, Guide, standard, certificate, or report issued by ABS shall be deemed to relieve any other entity of its duty or responsibility to comply with all applicable laws, including those related to the environment.

1.7 Scope of Certification

Nothing contained in any certificate or report is to be deemed to relieve any designer, builder, Owner, manufacturer, seller, supplier, repairer, operator, other entity or person of any duty to inspect or any other duty or warranty expressed or implied. Any certificate or report evidences compliance only with one or more of the Rules, Guides, standards, or other criteria of the American Bureau of Shipping, and is issued solely for the use of ABS, its Committees, its clients or other authorized entities. Nothing contained in any certificate, report, plan or document review or approval is to be deemed to be in any way a representation or statement beyond those contained in 1/1.5. ABS is not an insurer or guarantor of the integrity or safety of a vessel or of any of its equipment or machinery. The validity, applicability and interpretation of any certificate, report, plan or document review or approval are governed by the Rules, Guides and standards of the American Bureau of Shipping, who shall remain the sole judge thereof. ABS is not responsible for the consequences arising from the use by other parties of the Rules, Guides, standards, or other criteria of the American Bureau of Shipping, without review, plan approval and survey by ABS.

The term “approved” is to be interpreted to mean that the plans, reports or documents have been reviewed for compliance with one or more of the Rules, Guides, standards, or other criteria acceptable to ABS.

This Guide is published with the understanding that responsibility for reasonable container handling and securing operations, beyond the limit specified in the design basis of the container securing systems, does not rest upon the Committee.

3 Suspension and Termination of Certification

3.1 Suspension of Certification

Certification will be suspended and the Container Securing Certificate will become invalid from the date of any use, operation or other application of any container securing system for which it has not been approved and which affects or may affect certification or the structural integrity, quality, or fitness for a particular use or service.

Certification will be suspended and the Container Securing Certificate will become invalid if recommendations issued by the Surveyor are not carried out by their due dates and no extension has been granted.

3.3 Lifting of Suspension

Certification will be reinstated upon satisfactory completion of the rectification surveys. Such surveys will be credited as of the original due date. Certification will be reinstated after suspension for overdue recommendations upon satisfactory completion of the overdue recommendations.

3.5 Termination of Certification

ABS reserves the right to reconsider, withhold, suspend, or terminate the certificate of any container securing system for non-compliance with the Guide and Rules, for defects reported by the Surveyors which have not been rectified in accordance with their recommendations or for nonpayment of fees which are due on account of Container Securing System Surveys. Suspension or termination of certification may take effect immediately or after a specified period of time.

3.7 Notice of Surveys

It is the responsibility of the Owner to ensure that all surveys necessary for the certification are carried out at the proper time.

5 Rules for Certification

5.1 Scope

This Guide contains provisions for the certification of container securing systems installed aboard vessels classed by ABS including but not limited to:

- Below deck cell guide systems
- Below deck bridge strut and shoring systems
- Below deck lashing and lock fitting systems
- Above deck lashing and lock fitting systems
- Above deck buttress and deck cell guide systems

5.3 Alternatives

The Committee is at all times ready to consider alternative arrangements and designs which can be shown, through either satisfactory service experience or a systematic analysis based on sound engineering principles, to meet the overall safety, serviceability and strength standards of the applicable Rules and Guides.

The Committee will consider special arrangements or design for details of container securing systems which can be shown to comply with standards recognized in the country in which the container securing system are designed or built, provided these are not less effective than the requirements contained in this Guide.

5.5 Effective Date of Change of Requirement

5.5.1 Effective Date (1 May 2017)

This Guide and subsequent changes to this Guide are to become effective on the date specified by ABS.

5.5.2 Implementation of Rule Changes

In general, until the effective date, plan approval for designs will follow prior practice, unless review under the latest Guide is specifically requested by the party signatory to the application for certification. If one or more systems are to be constructed from plans previously approved, no retroactive application of the subsequent requirement changes will be required, except as may be necessary or appropriate for all contemplated construction.

5.7 ABS Type Approval Program

5.7.1 Type Approval

Products that are used as components for cargo container securing systems and can be consistently manufactured to the same design and specification may be Type Approved under the ABS Type Approval Program. The ABS Type Approval Program is a voluntary option for the demonstration of compliance of a product with the Rules or other recognized standards. It may be applied at the request of the designer or manufacturer. The ABS Type Approval Program generally covers Product Type Approval (1/5.7.3), but is also applicable for a more expeditious procedure towards Unit-Certification, as specified in 1/5.7.2.

The detail certification requirements for container securing devices are specified in 1/5.7.1 TABLE 1. The detail requirements for type approval of container securing systems are specified in 8/7 of this Guide.

TABLE 1
Certification - Container Securing Devices

<i>Container Securing Devices</i>	<i>Individual Unit Certification⁽¹⁾</i>	<i>Type Approval Program⁽²⁾</i>			
		<i>Product Design Assessment⁽³⁾</i>		<i>Manufacturing Assessment⁽⁴⁾</i>	
		<i>Design Review</i>	<i>Type Exam</i>	<i>Audit</i>	<i>PQA⁽⁵⁾</i>
1. Base sockets	d, m, s, t,	d, t	o	o	o
2. Bridge fittings	d, m, s, t	d, t	o	o	o
3. Container corner fittings	g	⁽⁶⁾	o	o	o
4. Fast acting twistlocks	d, m, s, t	d, t	o	o	NA
5. Lashings	d, m, s, t	d, t	o	o	o
6. Stacking cones	d, t	d, t	o	o	o

Notes

- Notations used in this column are:
d - design review by ABS.
m - material tests witnessed by Surveyor.
s - survey at the plant of manufacture including witnessing acceptance tests on production unit.
t - type/prototype testing conducted on an actual sample or a prototype model is required, as applicable.
g - certification by ABS not required; acceptance based on manufacturer's guarantee.
- For description of Type Approval Program, see 1A-1-A3/5 of the *ABS Rules for Conditions of Classification (Part 1)*.
- For description of Product Design Assessment, see 1A-1-A3/5.1 of the *ABS Rules for Conditions of Classification (Part 1)*.

- 4 For description of Manufacturing Assessment, see 1A-1-A3/5.3 of the *ABS Rules for Conditions of Classification (Part 1)*. Notations used in these columns are:
o - indicates the particular element of the program is optional
NA - indicates the particular element of the program is not applicable.
- 5 For description of Product Quality Assurance Certification (PQA), see 1A-1-A3/5.5 of the *ABS Rules for Conditions of Classification (Part 1)*.
- 6 Original equipment manufacturer (OEM) is to define the standard to be used in the evaluation.

5.7.2 Unit-Certification

Unit-Certification is a review of individual materials, components, products, and systems for compliance with ABS Rules, Guides or other recognized standards. This allows these items to be placed on a vessel, marine structure or system to become eligible for classification. Certification is a “one-time” review. The process is:

- i) A technical evaluation of drawings or prototype tests of a material, component, product or system for compliance with the ABS Rules, Guides, or other recognized standards.
- ii) A survey during manufacture for compliance with the ABS Rules, Guides, or other recognized standards and results of the technical evaluation.
- iii) Alternatively, a certificate of type approval (see below) will expedite the requirements of i) and ii) above.
- iv) Products found in compliance are issued “Individual Unit Certification”.
- v) There is no requirement for subsequent reviews or surveys.

5.7.3 Product Type Approval

Product Type Approval is a voluntary program used to prove eligibility for certification by demonstrating a product manufacturer’s conformance to a specific standard or specification. Manufacturers who can demonstrate the ability to produce consistent products in compliance with these standards are issued “Confirmations of Type Approval” (see 1A-1-A3/5.3.4 of the *ABS Rules for Conditions of Classification (Part 1)*). The Confirmation of Type Approval is neither an alternative to nor an equivalent of an Individual Unit Certificate. In order to remain valid, the Confirmation of Type Approval requires routine audits of the manufacturer and continued compliance of the product with existing or new specifications.

5.7.4 Approval on Behalf of Administrations

ABS has also been authorized and/or notified to type approve certain equipment on behalf of Administrations. The list of authorizations and notifications are maintained at each ABS Technical Office.

5.7.5 Applicable Uses of Type Approved Products

- i) When a product is at a stage suitable for testing and/or for use in a classed vessel, and unit certification is required, the manufacturer is to present the product to an attending Surveyor for witnessing of all required Rule testing. Unless specified in the Design Assessment, technical evaluation would not normally be required.
- ii) When a product is at a stage suitable for use in a classed vessel, and unit certification is not required, the product may be installed, to the satisfaction of the attending Surveyor, without the need for technical evaluation.

5.7.6 Definitions

Audit. A systematic and independent examination to determine whether quality activities and related results comply with planned arrangements and whether these arrangements are implemented effectively and are suitable to achieve the stated objectives.

General Audit. An audit that addresses the general operation of a site, and addresses applicable sections of the Quality and Environmental System Manual, quality and environmental system procedures, and operating procedures and process instructions.

Surveillance Audit. An audit that addresses specific areas within the operation at a site, and addresses selected sections of the Quality and Environmental System Manual, quality and environmental system procedures, and operating procedures and process instructions.

Audit Checklist. A listing of specific items within a given area that are to be audited.

Audit Report/Checklist. A combination of audit report and associated checklist.

Component. Parts/members of a product or system formed from material.

Finding. A statement of fact supported by objective evidence about a process whose performance characteristics meet the definition of non-conformance or observation.

Manufacturing Process. The process is the steps that one takes to produce (manufacture) a product.

Manufacturing System. The system is bigger than the manufacturing process, since it considers all of the factors that affect the process. This includes control of the process inputs, process controlling factors (such as competency of personnel, procedures, facilities and equipment, training, etc.) process outputs and measurements of quality, process and product for continual improvement, etc.

Material. Goods used that will require further forming or manufacturing before becoming a new component or product.

Non-conformance. Non-fulfillment of a specified requirement.

Observation. A detected weakness that, if not corrected, may result in the degradation of product or service quality or potential negative impact on the environment.

Original Equipment Manufacturer (OEM). The OEM is the person or legal entity that has the legal or patent rights to produce the material, component, product or system.

Product. Result of the manufacturing process.

Production Testing. This is the destructive and nondestructive examination of the materials and components used in the manufacture of a product and its final testing that is recorded in Unit Certification. The waiving of witnessed testing during production testing may only be allowed as defined in 1A-1-A3/3 "Limitations" and 1A-1-A3/5.5 "Product Quality Assurance Certification" of the *ABS Rules for Conditions of Classification (Part 1)*.

Prototype Testing. This is the destructive and nondestructive testing of the materials and components presented for evaluation of the original design of a product. If a Surveyor's witness is required, this may not be waived under any section of the Rules, unless it is done by a recognized third party.

Recognized Third Party. Is a member of the International Association of Classification Societies, a Flag Administration, Nationally Certified testing Laboratories or others who may be presented to ABS for special consideration.

Type Testing. This is the destructive and nondestructive testing of the materials and components of the first article of a product manufactured. If a Surveyor's witness is required, this may not be waived under any section of the Rules.

5.7.7 The Terms and Conditions for Use of ABS Type Approved Product Logo

When a product is eligible for a Confirmation of Type Approval [1A-1-A3/5.3.4 of the *ABS Rules for Conditions of Classification (Part 1)*], the Type Approved Product Logo may also be used with the understanding that it is copyrighted and its use must be controlled as follows:

- i)* Any advertisement or other use of the logo is to be presented to the Manager of ABS Programs for review prior to use
- ii)* The logo may only be used on correspondence, advertising and promotional material and must not be used except in connection with those goods or services described in the scope and conditions of the Product Design Assessment Certificate.
- iii)* The logo may be used only on those materials (i.e., Internet site, letterhead, marketing literature, advertising, invoice stock forms, packaging, etc.) relating to the particular facility and process/ product lines included within the Product Type Approval Certificate.
- iv)* The logo may not, under any circumstances, be used directly on or closely associated with products in such a way as to imply that the products themselves are “Unit-certified” by ABS.
- v)* If used with other logos, ABS may ask that the manufacturer discontinue any use of other logos that are unacceptable to ABS and any form of statement that, in the opinion of ABS, might be misleading.
- vi)* Upon the termination of certification, for whatever reason, the manufacturer must undertake to immediately discontinue all use of the logo and to destroy all stocks of material on which they appear.
- vii)* When advertising the product as ABS Type Approved, the manufacturer’s name, if different from the parent company, is to be used in conjunction with this logo. Any use should be specific to the process/product line covered and not represented as a blanket approval of the company.
- viii)* The logo may be scaled uniformly to any size necessary. The color of the logo shall be either black or blue (reflex blue or PMS 294 blue).
- ix)* Logos are available by e-mail from type_approval@eagle.org.

See the ABS Type Approved Product Logo, as follows:



See the *ABS Type Approval Program* in Appendix 1A-1-A3 of the *ABS Rules for Conditions of Classification (Part 1)*. The *ABS Type Approval Program* the indicated references are available for download from the ABS website at: <http://www.eagle.org>.

7 Other Regulations

7.1 International and Other Regulations

While this Guide covers the requirements for the certification of container securing systems, the attention of Owners, designers and builders is directed to the regulations of international, governmental and other authorities dealing with those requirements in addition to or over and above the classification requirements.

Where authorized by the Administration of a country signatory thereto and upon request of the Owners of a certified container securing system or one intended to be certified, ABS will survey for compliance with the provision of International and Governmental Conventions and Codes, as applicable.

7.3 Governmental Regulations

Where authorized by a government agency and upon request of the Owners of a new or existing container securing system, ABS will survey and certify a container securing system or one intended to be certified for compliance with particular regulations of that government on their behalf.

7.5 Other Rules

Where the vessel on which the container securing systems are installed is built in accordance with 1-1-4/7.5 of the *ABS Rules for Conditions of Classification (Part 1)*, ABS will consider the container securing systems constructed to the satisfaction of the Surveyors of ABS in accordance with the plans that have been approved to the Rules/Guides of another recognized classification society with verification of compliance by ABS.

9 Submission of Plans

A list of components and systems that are required for the certification of container securing systems is provided in 2/3. In most cases, manufacturer's component and system related drawings, calculations and documentation are required to be submitted to substantiate the design of the system or component. In these

cases, upon satisfactory completion of ABS review of the manufacturer's submittal, ABS Engineers will issue a review letter. This letter, in conjunction with the submitted package, will be used and referenced during surveys and subsequently issued reports by attending ABS Surveyors.

Upon satisfactory completion of all of the required engineering and survey processes, ABS will issue the Certificate for the container securing system.

11 Notification and Availability for Survey

The Surveyors are to have access to container securing systems at all reasonable times during initial installation.

The Surveyors are to undertake all surveys on container securing systems upon request, with adequate notification, of the Owners or their representatives, and are to report thereon to the Committee. Should the Surveyors find occasion during any survey to recommend further examination, notification is to be given immediately to the Owners or their representatives so that appropriate action may be taken.

13 Units

This Guide is written in two systems of units: SI units and US customary units. Each system is to be used independently of any other system. Unless indicated otherwise, the format of presentation of the two systems of units in this Guide is as follows:

SI units (US customary units)

15 Fees

Fees in accordance with normal ABS practice will be charged for all services rendered by ABS. Expenses incurred by ABS in connection with these services will be charged in addition to the fees. Fees and expenses will be billed to the party requesting that particular service.

17 Disagreement

17.1 Rules and Guides

Any disagreement regarding either the proper interpretation of Rules and Guides or the translation of Rules and Guides from the English language edition is to be referred to ABS for resolution.

17.3 Surveyor

In case of disagreement between the Owners or builders and the Surveyors regarding the material, workmanship, application of the Rules and Guides relating to any system classed or proposed to be classed by ABS, an appeal may be made in writing to the Committee, who will order a special survey to be held. Should the opinion of the Surveyor be confirmed, expense of this special survey is to be paid by the party appealing.

19 Limitation of Liability

The combined liability of the American Bureau of Shipping, its committees, officers, employees, agents or subcontractors for any loss, claim or damage arising from its negligent performance or nonperformance of any of its services or from breach of any implied or express warranty of workmanlike performance in connection with those services, or from any other reason, to any person, corporation, partnership, business entity, sovereign, country or nation, will be limited to the greater of a) \$100,000 or b) an amount equal to ten times the sum actually paid for the services alleged to be deficient.

The limitation of liability may be increased, up to an amount twenty-five times the sum paid for services, upon receipt of client's written request at or before the time of performance of services, and upon payment by client of an additional fee of \$10.00 for every \$1,000.00 increase in the limitation.

Under no circumstances shall American Bureau of Shipping be liable for indirect or consequential loss or damage (including, but without limitation, loss of profit, loss of contract, or loss of use) suffered by any person as a result of any failure by ABS in the performance of its obligations under these Rules. Under no circumstances whatsoever shall any individual who may have personally caused the loss, damage or expense be held personally liable.

21 Hold Harmless

The party requesting services hereunder, or his assignee or successor in interest, agrees to release ABS and to indemnify and hold harmless ABS from and against any and all claims, demands, lawsuits or actions for damages, including legal fees, to persons and/or property, tangible, intangible or otherwise which may be brought against ABS incidental to, arising out of or in connection with this Agreement, the work to be done, services to be performed or material to be furnished hereunder, except for those claims caused solely and completely by the negligence of ABS, its agents, employees, officers, directors or subcontractors. The parties agree that for the purposes of the Convention on Limitation of Liability for Maritime Claims, 1976, ABS is a person for whose acts the shipowner is responsible.

Any other individual, corporation, partnership or other entity who is a party hereto or who in any way participates in, is engaged in connection with or is a beneficiary of, any portion of the services described herein shall also release ABS and shall indemnify and hold ABS harmless from and against all claims, demands, lawsuits or actions for damages, including legal fees, to persons and/or property, tangible, intangible or otherwise, which may be brought against ABS by any person or entity as a result of the services performed pursuant to this Agreement, except for those claims caused solely and completely by the negligence of ABS, its agents, employees, officers, directors or subcontractors.

23 Time Bar to Legal Action

Any statutes of limitation notwithstanding, Owner's right to bring or to assert against ABS any and all claims, demands or proceedings whether in arbitration or otherwise shall be waived unless (a) notice is received by ABS within ninety (90) days after Owner had notice of or should reasonably have been expected to have had notice of the basis for such claims; and (b) arbitration or legal proceedings, if any, based on such claims or demands of whatever nature are commenced within one (1) year of the date of such notice to ABS.

25 Arbitration

Any and all differences and disputes of whatsoever nature arising out of services under these Rules shall be put to arbitration in the City of New York pursuant to the laws relating to arbitration there in force, before a board of three persons, consisting of one arbitrator to be appointed by ABS, one by the client, and one by the two so chosen. The decision of any two of the three on any point or points shall be final. Until such time as the arbitrators finally close the hearings either party shall have the right by written notice served on the arbitrators and on an officer of the other party to specify further disputes or differences under these Rules for hearing and determination. The arbitration is to be conducted in accordance with the rules of the Society of Maritime Arbitrators, Inc. in the English language. The governing law shall be the law of the State of New York, U.S.A. The arbitrators may grant any relief other than punitive damages which they, or a majority of them, deem within the scope of the agreement of the parties, including, but not limited to, specific performance. Awards made in pursuance to this clause may include costs including a reasonable allowance for attorney's fees and judgment may be entered upon any award made hereunder in any court having jurisdiction.

1 Scope (2024)

This Guide sets forth requirements for the certification of the initial installation of container securing systems and lashing calculation computer software aboard vessels classed by ABS. It is to be clearly understood that no representation is made as to the ability of any onboard container to withstand the loads allowed. The allowable loads have been derived from successful usage over a number of years and may exceed the design loads set forth in International Organization for Standardization (ISO) Standard 1496-1:1990, American National Standards Institute (ANSI) Standard MH 5.1.1M, the ABS *Rules for Certification of Cargo Containers*, and similar standards. It is the responsibility of the client, shipowner, or charterer to ascertain that the containers used in the system can withstand the loads applied to them.

It is also to be understood that no representation is made as to the absolute validity of the values for dynamic forces from roll, pitch, and heave, vessel vertical center of gravity, container spring constants, and lashing spring constants contained in this Guide. It is the responsibility of the client, shipowner, or charterer to establish the validity of the values for the above items used in the system.

The nonlinear nature associated with the container stacks and lashings requires a large amount of effort to determine the system forces. For this reason, a fully nonlinear software program “ABS Eagle C-Lash[®]” has been developed and is available to clients. Interested parties are kindly requested to contact the nearest ABS plan approval office for more information.

A vessel classed by ABS having an installed container securing system certified by ABS may be distinguished by the optional notation **CSC** in the *Record* for unrestricted service.

A computer lashing program to calculate forces acting on the container securing arrangements and maximum permissible stack weights for unrestricted service may be installed onboard a vessel, see 9/3.9.4. An onboard computer lashing program installed on a vessel assigned the **CSC** notation may be certified in accordance with Appendix A3 of this Guide and the vessel assigned the optional notation **CLP** for computer lashing program.

A vessel having an installed container securing system certified by ABS for operation in specific voyage trade routes where reduced accelerations are used in the calculation of forces acting on the container securing system, see 6/3.7.3, is to have an onboard certified computer lashing program, which is mandatory. Such operation may have a different maximum number and arrangement of containers than the unrestricted voyage trade. The suffix **V** is to be added to the Computer Lashing Program notation (**CLP-V**), to signify the certification of the Computer Lashing Program’s capability to address both unrestricted service and voyage-specific routes. **CLP-V** is mandatory for vessels that receive the optional **CSC** notation and apply voyage specific reductions. **The suffix (PARR) is to be added to the CLP-V notation to signify the certification of the Route Splitting reductions of the specific routes accompanied by digital onboard operational guidance for parametric roll detection and prevention installed as a standalone**

program or integrated into the onboard route planning or monitoring system. The **CLP-V(PARR)** notation is mandatory for vessels that apply the Route Splitting Reduction Factors.

CSC is a prerequisite for **CLP**, **CLP-V** and **CLP-V(PARR)**.

Typically, vessel stow planning is performed with an onboard computer lashing program that can calculate the maximum permissible stack weights for each individual stack based on the provided container lashing arrangements, and then the permissible stack weights are compared against the actual planned stack weights. Should an actual stack weight exceed the permissible, corrective action is to be taken by either reducing the stack weight or modifying the lashing arrangement accordingly.

Consideration regarding the use of the unrestricted lashing and stack weights or the voyage route-specific service lashing and stack weights rest with the vessel's Master depending on the anticipated conditions to be encountered during the voyage.

3 Submission of Plans and Design Data

3.1 General (2012)

Plans showing the arrangements and details of the container securing system are to be submitted for review. These plans are to clearly indicate the scantlings, materials, details, and rated strengths of the container securing system and the arrangements, dimensions, and weights of the containers. Plans are generally to be submitted electronically to ABS. However, hard copies will also be accepted.

3.3 Information to Be Submitted (2012)

The following plans and supporting data are generally to be submitted electronically to ABS. However, hard copies will also be accepted.

- Container stowage arrangement plans
- Cell guide arrangement and scantling plans
- Bridge strut or shoring system arrangement and scantling plans
- Buttress system arrangement and scantling plans
- Container lashing plans
- Details of securing fittings and lashing gear including certificates verifying breaking strength (i.e., prototype and production tests)
- Container loading conditions, to include as a minimum, the condition(s) with the maximum number of containers stowed above and below deck, and the contemplated container weights which result in the greatest metacentric height (GM). The assumed container weights and the location of the center of gravity of the container, if different from 45% of the container height above the base; as well as the vessel particulars including vertical center of gravity, center of flotation, transverse metacentric height, and draft are to be submitted.
- Detailed ship motion studies and calculations, if available
- Securing system calculations
- Container securing manual

5 Definitions and Symbols

Where directions, such as longitudinal, transverse, and vertical, are used in the Guide, they refer to motions, accelerations, or forces that are aligned with the principal axes of the vessel.

5.1 Definitions

The following definitions are given to provide a clearer understanding of terms that are used in the Guide.

<i>Base Sockets</i>	Flush or raised sockets which are welded to the deck, hatch cover or container support foundation and which provide a means of securing the container to the base structure by means of a <i>Lock Fitting</i> or similar device. Other commonly used expressions or terms include: <i>Deck Sockets</i> or <i>Twistlock Foundations</i> . See 4/5.3 FIGURE 5.
<i>Bay</i>	An athwartship block of containers associated with a hatch or hatch cover containing multiple stacks (or rows). See 2/7 FIGURE 1.
<i>Block Stowage</i>	Stowage configuration where several adjacent stacks of containers are connected at one or more tiers. See also <i>Container Block</i>
<i>Bridge Fitting</i>	A device which connects the topmost corner fittings of two adjacent stacks of containers. See 4/3.1.3 FIGURE 3.
<i>Bridge Strut</i>	An adjustable device connecting the outboard-most stack of a below deck block of containers to the vessel's structure when cell guides are not used. Also referred to as <i>Tension/Pressure fitting</i> . See 4/3.1.3 FIGURE 3.
<i>Buttress</i>	A deck mounted tower-like structure which provides horizontal restraint for stacks of deck stowed containers. Portable "locking frames" are sometimes used to connect the container corner fittings to the buttress.
<i>Cell Guides</i>	A rigid securing system of vertical steel angles, spaced with some margin on container length and width that provides alignment and horizontal restraint for container stacks.
<i>Container Block</i>	A number of container stacks interconnected by double stacking cones and/or bridge fittings. Also referred to as <i>Block Stowage</i> .
<i>Container Stack</i>	A single vertical stack of containers which may be secured by lock fittings, lock fittings plus lashings, or cell guides.
<i>Corner Fitting</i>	A fixture, typically a casting, consisting of standard apertures and faces, which provide a common interface for handling and securing containers. It is an integral part of the container end frame structure and is generally in compliance with ISO Standard 1161. A similar fitting can also be found at intermediate posts located some distance from the end frame structure (such as at the 40-ft location on a 45-ft container).
<i>Corner Posts</i>	Reinforced vertical structure between the corner fittings at the ends of containers designed to take the compression and tension forces exerted by lifting, stacking, and securing. Some containers also have intermediate 'corner' posts located some distance in from their ends at a nominal 40-ft spacing. See also <i>Side (Stacking) Post</i>
<i>Cross Ties</i>	A shoring system transferring transverse loads athwartship from cell guides to vessel's structure
<i>CSC Plate</i>	Safety Approval Plate under the International Convention for Safe Containers (CSC), Ref. 6, to be affixed to all freight containers for use at sea (as required by SOLAS). Containers shall not be loaded to more than the maximum gross weight indicated on the CSC plate.
<i>Design Breaking Load</i>	The design breaking load of a component as determined by test of a representative sample. The design breaking load is not to be more than the last load recorded during the test prior to failure. Also referred to as <i>Minimum Breaking Strength (MBS)</i> .
<i>Domestic Containers</i>	Containers designed and built for conveyance by road or rail only. They may not have strength sufficient for marine use and/or fittings in standard locations for shipboard lifting, stacking, and securing.
<i>Double Stacking Cone</i>	A device which fits into container corner fittings to connect adjacent stacks of containers when cell guides are not used.

<i>Fully Automatic Twistlock (FAT)</i>	A twistlock that is inserted and secured in the four bottom corner fittings on the quay before the container is stowed on top of another container onboard the vessel. The geometry of the twistlock design engages the corner fittings of the lower container and does not require stevedores to lock or unlock the fitting when stowing or discharging containers. Special approval is required for certification of a fully automatic twistlock.
<i>Flexible Securing System</i>	System where the stiffness of the container and securing components affect the securing forces and forces developed in the end frame structure of the containers; for example, lashing systems.
<i>High-Cube Container</i>	Container similar in structure to ISO standard containers, but taller. While a standard container has a maximum height of 2591 mm (8'-6"), a high-cube container is 2896 mm (9'-6") tall. Also referred to as <i>hi-cube container</i> .
<i>ISO Freight Container</i>	Containers meeting the design dimensions and ratings of ISO container standards such as: <u>ISO 1496-1 - Series 1 freight containers</u> , Ref. 1. This sets out the basic requirements for containers suitable for international conveyance by road, rail and sea. <u>ISO 668 - External dimensions and ratings</u> , Ref. 2. This standard specifies only dimensions and maximum gross weight (R). <u>ISO 1161 - Corner fittings and specifications</u> , Ref. 3.
<i>Lashing Assembly</i>	A tension element made-up of a rod, wire rope or chain, a tensioning device, and a lashing point; used to secure a stack of containers.
<i>Lashing Bridge</i>	An athwartship, elevated platform between hatches on deck from which container stacks on the hatch covers or deck may be secured with lashing assemblies.
<i>Lashing Points (Eyes)</i>	Fittings welded to the deck, hatch cover, or pedestal that connect the end of a lashing assembly to the vessel structure or hatch covers. These include "D"-rings, fixed or hinged lashing plates, pad eyes, etc. See 4/5.5 FIGURE 6.
<i>Linkage Plate</i>	A plate that fits over twistlocks or single stacking cones and connects adjacent stacks of containers.
<i>Lock Fitting</i>	A device inserted into a container corner fitting which can transmit tensile and shear loads associated with the separation forces in a stack of containers. <i>Twistlocks</i> or <i>pin locks</i> are common lock fittings. See 4/3.1.2 FIGURE 2.
<i>Longitudinal Ties</i>	A shoring system transferring longitudinal loads fwd/aft from cell guides to vessel's structure. These can be tension only elements (e.g., steel wire pendants) or tension/compression members.
<i>Maximum Securing Load (MSL)</i>	The <i>MSL</i> is the allowable load capacity for a device used to secure a container. The term <i>Safe Working Load (SWL)</i> is also used.
<i>Minimum Breaking Strength (MBS)</i>	The <i>MBS</i> is the minimum expected load at which the fitting will fail. Also referred to as <i>Design Breaking Load</i>
<i>Pad Eye</i>	See <i>Lashing Point (Eyes)</i>
<i>Proof Load (PL)</i>	A test load applied to a container securing device during production testing. Generally, the proof load is the safe working load (<i>SWL</i>) of the device multiplied by a factor of 1.1.
<i>Prototype Securing Device</i>	A representative unit of a series of container securing devices or fittings.
<i>Racking</i>	Distortion of the container end or side due to horizontal forces.
<i>Racking Force or Load</i>	Resultant horizontal force on a container end or side from the horizontal static and dynamic forces from ship motions, the securing forces from lashing or shoring, and the self-racking force of the container in question.
<i>Rigid Container Securing System</i>	System where the racking stiffness of the containers does not materially affect the securing forces and forces developed in the end frame structure of the containers; for example, cell guides.

<i>Row (or Stack)</i>	A single vertical stack of containers containing one or more tiers. Also referred to as a <i>stack</i> . See 2/7 FIGURE 2.
<i>Safe Working Load (SWL)</i>	The <i>design breaking load</i> or <i>minimum breaking strength (MBS)</i> of a securing device divided by an appropriate safety factor. The maximum resultant load upon a component is not to exceed the <i>SWL</i> . See also <i>Maximum Securing Load (MSL)</i> .
<i>Semi-Automatic Twistlock (SAT)</i>	A twistlock that is inserted and secured in the four bottom corner fittings on the quay before the container is stowed on top of another container on board the vessel. When the container is landed on top of another container, a spring mechanism in the twistlock automatically engages and secures the container above to the container below. This type of twistlock must be manually released or unlocked to discharge the container above. See 4/3.1.2 FIGURE 2.
<i>Self-Racking Force</i>	That portion of the container's own gross weight which contributes to the racking load on the container.
<i>Side (Stacking) Post</i>	The vertical part of the container side between upper and lower container fittings that is reinforced to take stacking and lifting loads. These posts are usually provided on containers greater than 40-ft to facilitate standard lifting and stacking at a 40-ft spacing. See also <i>Corner Post</i> .
<i>Shoring</i>	A pad, rail, brace, or framework which provides horizontal support for containers.
<i>Single Stacking Cone</i>	A device inserted into a container corner fitting which provides alignment and shear restraint in a stack of containers when cell guides are not used. It provides no tension restraint. See 4/3.1.1 FIGURE 1.
<i>Stack (or Row)</i>	A single vertical stack of containers containing one or more tiers. Also referred to as a <i>Row</i> . See 2/7 FIGURE 2.
<i>Tensioning Device</i>	An adjustable device used to tighten a lashing (i.e., turnbuckle). See 4/3.3.2.
<i>Tension/Pressure Fitting</i>	An adjustable device connecting the outboard-most stack of a below deck block of containers to the vessel's structure when cell guides are not used. Also referred to as <i>Bridge Strut</i> .
<i>Tier of Containers</i>	In a block of containers consisting of one or more stacks, those containers at the same vertical location in each stack would be considered to be in the same tier.
<i>Tier</i>	An indication of the vertical position of a container in a stack. The first tier is the lowest or bottom-most position in the stack.
<i>Turnbuckle</i>	A specific type of <i>Tensioning Device</i> . See 4/3.3.2.
<i>Twistlock</i>	A fitting inserted into corner fittings and used to secure containers stacked on top of each other in tension, compression, and shear. This is a specific type of <i>Lock Fitting</i> . See 4/3.1.2 FIGURE 2.
<i>Wind Exposed Container</i>	Any container with more than one-third of its lateral area exposed to the wind, either above the top or beyond the ends of adjacent containers. If there is more than 5 m (nominally two-container stacks) transverse separation between the subject container and the adjacent container, the entire subject container is considered wind exposed.
<i>Weather Stack</i>	Any stack of containers in which all containers are wind exposed and, therefore, have a wind load applied. A weather stack need not be the outboard-most stack.

5.3 Symbols

Symbols used in the Guide have the following definitions:

5.3.1 Vessel Particulars

<i>L</i>	=	vessel's length between perpendiculars, in m (ft)
<i>B</i>	=	vessel's molded breadth, in m (ft)
<i>D</i>	=	vessel's molded depth, in m (ft)

d = vessel's draft to the summer load line, in m (ft)

GM = transverse metacentric height, in m (ft)

5.3.2 Motions and Accelerations

<i>Symbols</i>	<i>Description</i>	<i>Section Reference</i>
T_R, T_P, θ, ϕ	Natural roll and pitch period and amplitude	6/3.5.2, 6/3.7 FIGURE 1
k_r, C	Constants used in roll and pitch calculations	6/3.5.2
R_{CTR}, P_{CTR}	Roll and pitch center	6/3.5.2, 6/3.7 FIGURE 1
x_C, y_C, z_C	Longitudinal, transverse, and vertical distance from vessel origin to center of gravity of container	6/3.7, 6/3.7 FIGURE 1
a_0, k_C, k_3	Constants used in acceleration calculations	6/3.7
$A_T, A_{VMAX}, A_{VMIN}, A_L$	Accelerations at a point in the transverse, vertical (max and min), and longitudinal directions.	6/3.7.1 and 6/3.7.2
$a_{GT}, a_{RT}, a_{GRV}, a_{RV},$ $a_{GPV}, a_{PV}, a_{GL}, a_{PL}$	Acceleration components in the transverse, vertical, and longitudinal directions due to gravity, roll, and pitch	6/3.7.1 and 6/3.7.2

5.3.3 Container Properties and External Forces (1 May 2017)

<i>Symbols</i>	<i>Description</i>	<i>Section Reference</i>
$W_{(i)}$	Gross container weight in tier (i)	6/3.13.1
$L_{C(i)}, H_{C(i)}$	Length and height of container in tier (i)	6/3.13.4
K_{CT}, K_{CL}	Container racking spring constants at ends for deflection in transverse direction and in sides for longitudinal deflection	3/7
$P_W, F_{W(i)}$	Wind pressure and wind force at tier (i)	6/3.13.4
$F_{H(i)}, F_{L(i)}, F_{V(i)}$	Force components at tier (i) in the horizontal (transverse), longitudinal, and vertical directions.	6/3.13.1 to 6/3.13.3

5.3.4 Lashing Properties (1 February 2017)

<i>Symbols</i>	<i>Description</i>	<i>Section Reference</i>
E_ℓ	Equivalent elastic modulus of the lashing assembly	4/3.5.2 TABLE 2
A_ℓ	Cross sectional area of lashing assembly tension element	4/3.5.2 TABLE 1
L_ℓ, L_Z, L_Y, L_X	Total length of lashing assembly and its vertical (Z), transverse (Y), and longitudinal (X) projection	4/3.5.2, 6/5.5

7 Descriptions of Container Stowage Locations

The following terms, used to describe container stowage locations (slot numbering system) onboard ship, are derived from Ref. 4, ISO standard 9711-1:1990. The ISO Bay Plan System is shown Section 2, Figures 1 and 2

<i>Bay</i> or Bay Number	An athwartship row of containers associated with a hatch or hatch cover that identifies longitudinal location and container length (even numbers are used for 40-ft containers and odd numbers generally refer to 20-ft containers).
<i>Row</i> or Row Number	A vertical stack of containers that identifies transverse location from centerline. Also referred to as <i>Stack</i> or <i>Stack Number</i>
<i>Tier</i> or Tier Number	A horizontal group of containers that identifies the vertical location from a reference point - typically from the inner bottom below deck and from the weather deck or hatch cover on deck.

FIGURE 1
ISO Bay Numbering Scheme

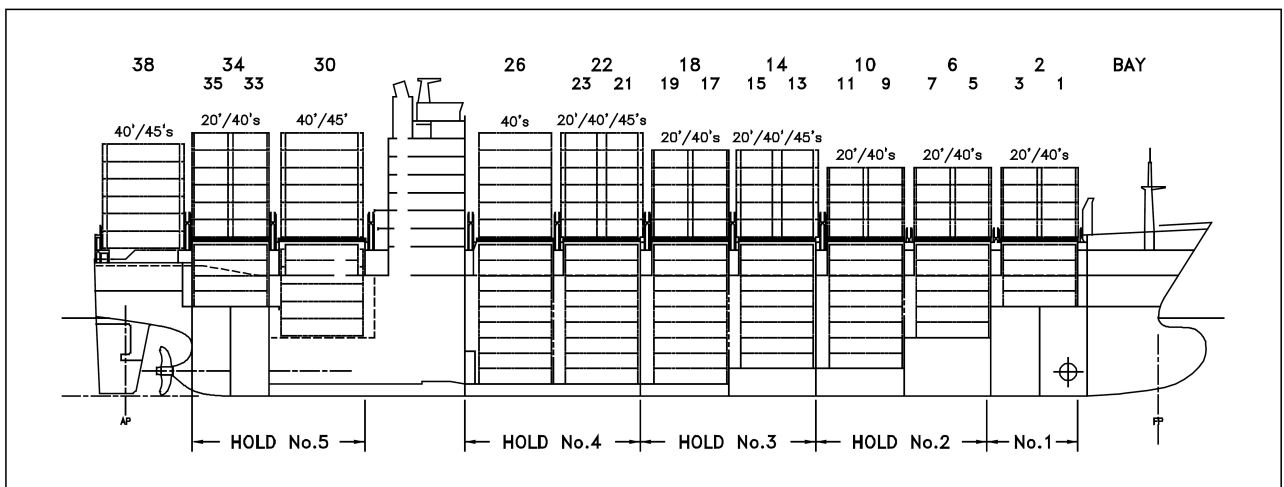

The ISO Bay Plan system utilizes a six digit number to uniquely describe each container slot location.

The first two digits indicate the bay number. The first 40-ft container bay starting at the bow is 02 and each 40-ft bay thereafter is numbered in increments of 4 (02, 06, 10, 14, 18,...). 20-ft container bays use the odd numbers preceding and following the 40-ft bay numbers. For example the bay numbers for the 20-ft containers stowed on the same hatch cover as the 40-ft at bay 14 would be bays 13 and 15.

The third and fourth digits indicate the row or stack number. For a stowage arrangement with an even number of bays in the hold or on deck, the odd numbered stacks are numbered sequentially (by 2's) on the starboard side, beginning with 01 at the stack closest to centerline, and similarly for the even numbers on the port side. For an odd number of rows on deck, the centerline stack is numbered 00, the starboard stacks are numbered 01, 03, 05,...; and the port stacks are numbered 02, 04, 06,....

The fifth and sixth digits indicate the tier number. Below deck, the first tier just above the inner bottom is 02. Each tier above is numbered sequentially by 2's (02, 04, 06, 08, 10,...). The first tier on deck is 82 and for each tier above, the number increases by 2 (82, 84, 86, 88, 90,...).

FIGURE 2
ISO Stack/Row and Tier Numbering Scheme

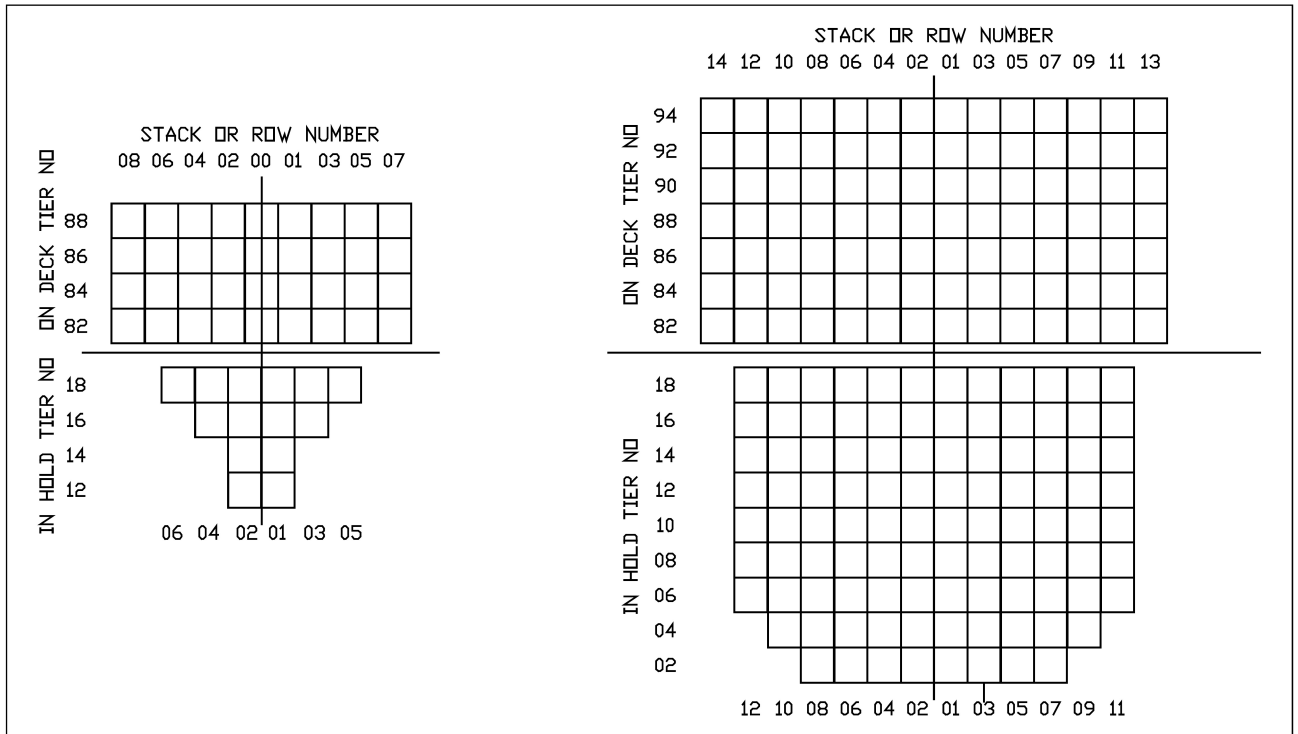

SECTION 3 Container Characteristics

1 General

All cargo containers used for ocean transport are to have a proper CSC Approval Plate affixed (as defined in the IMO International Convention for Safe Containers 1972, Ref. 5) and should meet the minimum strength and load requirements of ISO 1496-1:1990, Ref. 1. Where special containers are used for unique cargoes that have reduced or increased load capacities, these limitations shall be considered when stowing them onboard ship and also when determining permissible tier and container stack weights.

3 Dimensions

The premise of this Guide is that the dimensions of the containers and characteristics of the corner fittings or castings are in agreement with the international standards given in ISO 668:1995 and ISO 1161:1984. Even so, there are some ocean transport containers that are not defined by these references, and Section 3, Table 1 and Table 2 are offered as a brief summary of the dimensions for standard ISO containers and for some additional commonly used container sizes.

TABLE 1A
External Container Dimensions and Tolerances SI & MKS Units

<i>Nominal Size</i>	<i>Gross Mass</i>	<i>External Dimensions</i>					
		<i>Length</i>	<i>Tolerance</i>	<i>Width</i>	<i>Tolerance</i>	<i>Height</i>	<i>Tolerance</i>
	<i>kg</i>	<i>mm</i>	<i>mm</i>	<i>mm</i>	<i>mm</i>	<i>mm</i>	<i>mm</i>
10 ft ISO 668	10,160	2991	+0/-5	2438	+0/-5	2438	+0/-5
20 ft ISO 668	30,480	6058	+0/-6	2438	+0/-5	2438	+0/-5
						2591	+0/-5
30 ft ISO 668	30,480	9125	+0/-10	2438	+0/-5	2591	+0/-5
						2896	+0/-5
40 ft ISO 668	30,480	12192	+0/-10	2438	+0/-5	2591	+0/-5
						2896	+0/-5
45 ft	30,480	13716	+0/-10	2438	+0/-5	2896	+0/-5
48 ft	30,480	14630	+0/-10	2591	+0/-5	2908	+0/-5
53 ft	30,480	16154	+0/-10	2591	+0/-5	2908	+0/-5

TABLE 1B
External Container Dimensions and Tolerances US Units

Nominal Size	Gross Mass	External Dimensions					
		Length	Tolerance	Width	Tolerance	Height	Tolerance
	lb	ft-in	in.	ft-in	in.	ft-in	in.
10 ft ISO 668	22,400	9'-9 ³ / ₄ "	+0/- ³ / ₁₆	8'-0"	+0/- ³ / ₁₆	8'-0"	+0/- ³ / ₁₆
20 ft ISO 668	67,200	19'-10 ¹ / ₂ "	+0/- ¹ / ₄	8'-0"	+0/- ³ / ₁₆	8'-0"	+0/- ³ / ₁₆
						8'-6"	+0/- ³ / ₁₆
30 ft ISO 668	67,200	29'-11 ¹ / ₄ "	+0/- ³ / ₈	8'-0"	+0/- ³ / ₁₆	8'-6"	+0/- ³ / ₁₆
						9'-6"	+0/- ³ / ₁₆
40 ft ISO 668	67,200	40'-0"	+0/- ³ / ₈	8'-0"	+0/- ³ / ₁₆	8'-6"	+0/- ³ / ₁₆
						9'-6"	+0/- ³ / ₁₆
45 ft	67,200	45'-0"	+0/- ³ / ₈	8'-0"	+0/- ³ / ₁₆	9'-6"	+0/- ³ / ₁₆
48 ft	67,200	48'-0"	+0/- ³ / ₈	8'-6"	+0/- ³ / ₁₆	9'-6.5"	+0/- ³ / ₁₆
53 ft	67,200	53'-0"	+0/- ³ / ₈	8'-6"	+0/- ³ / ₁₆	9'-6.5"	+0/- ³ / ₁₆

TABLE 2A
Container Corner Fitting Dimensions and Tolerances SI & MKS Units

Nominal Size	Gross Mass	Dimensions Center to Center of Corner Fittings			
		Length	Tolerance	Width	Tolerance
	kg	mm	mm	mm	mm
10 ft ISO 668	10,160	2787	+3/-5	2259	+0/-5
20 ft ISO 668	30,480	5853	+3/-5	2259	+0/-5
30 ft ISO 668	30,480	8918	+4/-6	2259	+0/-5
40 ft ISO 668	30,480	11985	+4/-6	2259	+0/-5
45 ft	30,480	11985	+4/-6	2259	+0/-5
		13509	+4/-6		
48 ft	30,480	11985	+4/-6	2259	+0/-5
		14422	+4/-6		
53 ft	30,480	11985	+4/-6	2259	+0/-5
		15947	+4/-6		

TABLE 2B
Container Corner Fitting Dimensions and Tolerances US Units

Nominal Size	Gross Mass	Dimensions Center to Center of Corner Fittings			
		Length	Tolerance	Width	Tolerance
	lb	ft-in	in.	ft-in	in.
10 ft ISO 668	22,400	9'-1 ²³ / ₃₂ "	+ ¹ / ₈ / - ³ / ₁₆	7'-4 ³¹ / ₃₂ "	+0 / - ³ / ₁₆
20 ft ISO 668	67,200	19'-2 ⁷ / ₁₆ "	+ ¹ / ₈ / - ³ / ₁₆	7'-4 ³¹ / ₃₂ "	+0 / - ³ / ₁₆
30 ft ISO 668	67,200	29'-3 ¹ / ₈ "	+ ⁵ / ₃₂ / - ¹ / ₄	7'-4 ³¹ / ₃₂ "	+0 / - ³ / ₁₆
40 ft ISO 668	67,200	39'-3 ⁷ / ₈ "	+ ⁵ / ₃₂ / - ¹ / ₄	7'-4 ³¹ / ₃₂ "	+0 / - ³ / ₁₆
45 ft	67,200	39'-3 ⁷ / ₈ "	+ ⁵ / ₃₂ / - ¹ / ₄	7'-4 ³¹ / ₃₂ "	+0 / - ³ / ₁₆
		44'-3 ⁷ / ₈ "	+ ⁵ / ₃₂ / - ¹ / ₄		
48 ft	67,200	39'-3 ⁷ / ₈ "	+ ⁵ / ₃₂ / - ¹ / ₄	7'-4 ³¹ / ₃₂ "	+0 / - ³ / ₁₆
		47'-3 ⁷ / ₈ "	+ ⁵ / ₃₂ / - ¹ / ₄		
53 ft	67,200	39'-3 ⁷ / ₈ "	+ ⁵ / ₃₂ / - ¹ / ₄	7'-4 ³¹ / ₃₂ "	+0 / - ³ / ₁₆
		53'-3 ⁷ / ₈ "	+ ⁵ / ₃₂ / - ¹ / ₄		

When containers with other dimensions are to be used, they should be addressed in the documents submitted for approval.

5 Permissible Container Loads and Strength Ratings

The combined static, dynamic, and securing loads imposed on the container structure are not to exceed those given in 3/5 TABLE 3 for standard 20-ft and 40-ft containers. These limits are derived, in part, from ISO1496-1:1990.

The allowable loads for standard 45-ft containers are to be assumed equivalent to those for 40-ft containers given in 3/5 TABLE 3 when the 45-ft containers are supported and loaded at the end walls or at the 40-ft points.

48-ft and 53-ft containers are not commonly used in many services, and an industry standard for strength ratings has yet to be developed. If no specific container strength test data is available for these containers, the strength ratings for 40-ft containers given in 3/5 TABLE 3 may be used for the design of the securing system if the 48-ft containers and 53-ft containers are supported and loaded only at the end walls. If additional sets of stacking posts are used, see the guidance in 3/5.3.

The design container loads given in 3/5 TABLE 3 are illustrated in 3/5 FIGURE 1.

TABLE 3
Design Loads on Containers and Container Fittings (1 February 2017)

Nominal Container Size:	20-ft Container		40-ft Container	
	Maximum Gross Weight:	30.48 tonnes	30 Lton	30.48 tonnes
Units:	kN	Ltf	kN	Ltf
End Wall Racking	150	15.0	150	15.0
Side Wall Racking	150	15.0	150	15.0

<i>Nominal Container Size:</i>			<i>20-ft Container</i>		<i>40-ft Container</i>	
<i>Maximum Gross Weight:</i>			<i>30.48 tonnes</i>	<i>30 Lton</i>	<i>30.48 tonnes</i>	<i>30 Lton</i>
<i>Units:</i>			<i>kN</i>	<i>Ltf</i>	<i>kN</i>	<i>Ltf</i>
Corner Post Compression			848	85.1	848	85.1
Transverse Securing Force on Corner Fitting:	Top Corner	Tension	250	25.1	250	25.1
		Compression	250	25.1	250	25.1
	Bottom Corner	Tension	350	35.1	350	35.1
		Compression	350	35.1	350	35.1
Longitudinal Securing Force on Corner Fitting:	Top Corner	Tension	100	10.0	100	10.0
		Compression	50	5.0	50	5.0
	Bottom Corner	Tension	200	20.1	300	30.1
		Compression	200	20.1	300	30.1
Lashing Force on Top and Bottom Corner Fitting due to Internal Lashing (See 3/5 FIGURE 1)		Vertical	300	30.1	300	30.1
		Horizontal	225	22.6	225	22.6
Lashing Force due to External Lashing	Top Corner	Vertical	300	30.1	300	30.1
		Horizontal	225	22.6	225	22.6
	Bottom Corner	Vertical	300	30.1	300	30.1
		Horizontal	150*	15.0*	150*	15.0*
Vertical Tension on Top Corner Fitting			250	25.1	250	25.1
Vertical Tension on Bottom Corner Fitting			250	25.1	250	25.1

* Higher values are to be specially considered.

For containers which cannot support the above loads due to the container construction standards, the loads are to be properly reduced. See 2/1.

FIGURE 1
Design Loads for ISO 20-ft and 40-ft Containers (1 February 2017)

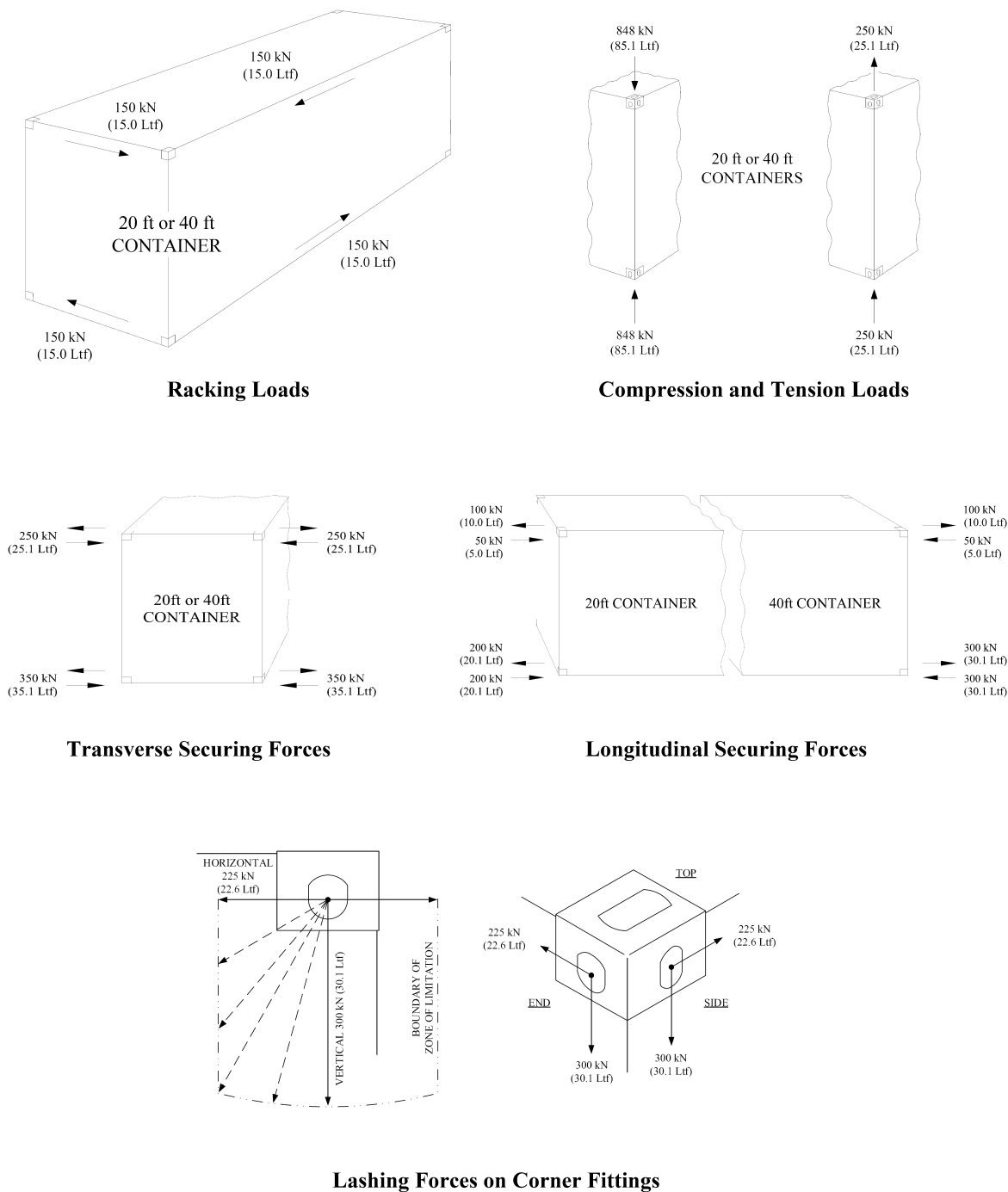

5.1 Permissible Forces on Corner Fittings

The permissible horizontal securing and shoring forces on 20-ft and 40-ft containers listed in 3/5 TABLE 3 are illustrated in 3/5 FIGURE 1. Note that the bearing area for all securing fittings must be evaluated to ensure that the local shear force in the sides of the corner fitting does not exceed 34% of yield for the maximum design load.

The design vertical and horizontal lashing loads that may act on the upper and lower container corner fittings in either vertical plane are given in 3/5 TABLE 3 and illustrated in 3/5 FIGURE 1.

5.3 Containers with Stacking Posts Offset from the End Walls

Most containers greater than 40-ft in length have stacking posts at locations offset from the end walls that match the spacing of the corner posts on 40-ft containers. This facilitates the stowage of these longer containers over the top of 40-ft containers (or any containers with stacking posts at 40-ft spacing) or at hatch locations with 40-ft base sockets. Over-wide containers (48-ft containers and 53-ft containers) also typically have special fittings at the top and bottom of the stacking posts that have apertures with a transverse separation that matches the standard width container.

These longer containers with the 40-ft stacking posts permit a wide variety of mixed length stack configurations. There are limitations based on the ability to operate twistlocks and apply lashings, but considerable variability still exists where the containers are supported from below and loaded from above (a function on where twistlocks are placed and lashings applied).

When designing the securing system, the location of support at the bottom of the container and application of load at the top of the container becomes critical for these longer containers. The capacity of these containers to support vertical loads (compression from containers above or lashing loads) can be limited if the support is at a stacking post while the load is applied at the end wall (or vice versa). The compressive strength rating of a container in such a situation can be much less than that of the strength of the end wall corner posts. The stacking posts are also usually less robust than the corner posts and can support less compression even when loaded and supported at the same post. Because the stacking posts in the side wall do not provide a direct load path to the aperture at the standard spacing, there is a moment induced in the bottom fitting unless a special extra-wide twistlock is used.

7 Racking Spring Constants

In the absence of container test data or container specifications, the values given in 3/7 TABLE 4 shall be used for standard ISO containers ranging in height from 2438 mm to 2908 mm (8' to 9'-6.5").

TABLE 4
Racking Spring Constant, K_C and K_{CL}

<i>Panel Location</i>	<i>Container Racking Spring Constant</i>	
	<i>kN/mm</i>	<i>Ltf/in</i>
Container Door End, K_C	3.73	9.50
Container Closed End, K_C	15.69	40.0
Container Side, K_{CL}	5.79	14.75

For non ISO containers, the racking spring constants are to be determined based on container test data in consultation with ABS.

7.1 Specialty Containers

Containers used for the transport of unique cargo with unusual or non-standard dimensions and structure and with reduced racking strength or racking spring characteristics shall be evaluated separately and shall be clearly defined in general stowage operations. It is good practice to stow containers with reduced racking strength within cell guides or in the uppermost tiers on deck where racking loads are not severe.

7.3 Containers with One or Both Doors Removed

Containers that have one or both doors removed for the transport of special cargoes shall be assumed to have reduced racking strength and shall similarly be stowed within cell guides or in the uppermost tiers on deck.

9 Container Strength Tests

Tests shall be conducted on prototypes of unusual containers to establish the permissible values for the strength parameter listed in 3/5 TABLE 3. Such testing shall follow the procedures and requirements described in the *ABS Rules for Certification of Cargo Containers*.

SECTION 4 Securing Devices

1 General

All devices and other elements used to secure containers onboard a vessel, whether they are fixed to the hull structure or loose fittings, are to meet the minimum strength requirements described in this Section. Determination of the forces imposed on each device or element is discussed in Section 6, “Securing System Design Principles”. The selection, arrangement, and use, of the devices shall also be in accordance with the guidance given in Section 5, “Container Securing Arrangements”.

Instructions for proper installation, use, inspection, maintenance, and lubrication of securing components are to be included in the Container Securing Manual (refer to Section 9). It is important to note that in a seaway, the changing direction of the accelerations acting on the containers and the gaps in most fittings securing the containers create a system where components do slide on one another. This can result in significant abrasion and wear. It is recommended that all loose components be inspected and inventoried regularly. If any loose components are found defective they shall be marked and removed from service. Fixed securing devices are to be visually inspected regularly for damage such as cracking or deformation that would make them inoperable or incapable of transmitting load to the hull structure.

3 Loose Fittings

Securing devices that are not permanently attached to the hull structure and that can be removed for storage or maintenance are “loose fittings”. These include fittings that pass loads between containers (for example, twistlocks, stackers, and bridge fittings), and fittings that pass loads from containers to the hull structure (for example, lashing assemblies and bridge struts).

3.1 Twistlocks, Stackers, and Other Container Connectors

These fittings are designed to fit the openings in the container corner castings and connect the container to another container or to fixed securing fittings. They are to be designed to pass compression and shear loads and when designed with a locking mechanism, tensile loads.

3.1.1 Stackers or Stacking Cones

These pass compression and shear loads only. They are used with containers where corner post tension restraint is not required. Double stackers connect two container stacks and can provide some translational restraint for the stack.

The cones on these fittings are sized slightly smaller than the openings in the container corner castings. This allows some sliding to occur before the cones engage the container and restrain horizontal movement.

FIGURE 1
Sample Stacker

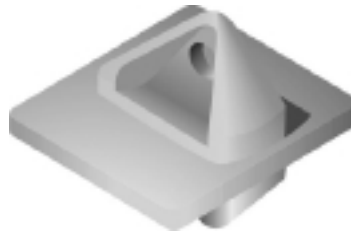

3.1.2 Lock Fittings

Lock fittings are similar to stackers but have the capability to pass tension loads. They are commonly called twistlocks and come in manual, semi-automatic, and fully automatic types. The manual twistlocks require an operator to lock and unlock the fitting. Semi-automatic twistlocks can be locked automatically when the containers are set in place, but must be manually unlocked. The fully automatic twistlocks do not require manual locking or unlocking, relying instead on slight tipping/rotation of the container above to disengage the fitting.

As is the case for stacking cones, lock fittings allow containers to slide horizontally before the fittings engage and restrain horizontal movement. Likewise, there are gaps between the tension elements and the corner castings that allow some vertical separation of containers to occur before the tension is restrained.

FIGURE 2
Sample Lock Fittings

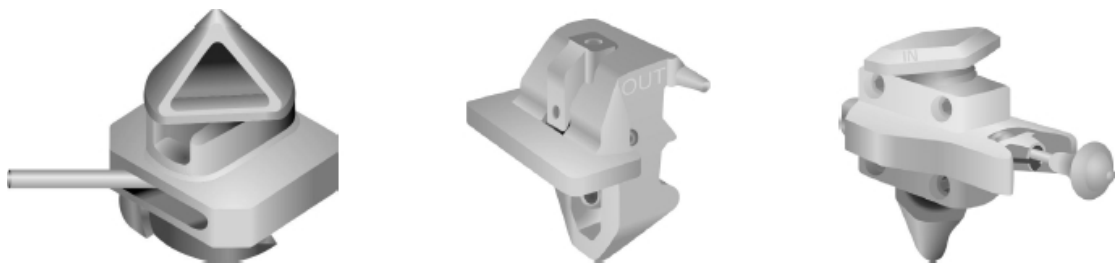

3.1.3 Bridge Fitting, Bridge Strut

Bridge fittings are designed to connect the topmost containers in a stack with an adjacent stack of exactly the same height. They can support tensile or compressive loads in a horizontal direction and are used to connect independent stacks of containers into a block that may better resist overturning moments. Often bridge fittings are used in conjunction with bridge struts to pass transverse loads from connected stacks to the hull structure.

Bridge fittings and struts are typically adjusted with a threaded element that forms a tight connection in tension, or both tension and compression, with little tolerance for sliding or movement. However, in a seaway, other elements of the stack can slide and may loosen the bridge and strut fittings. The affect of clearances that can develop in service are to be taken into account during the assessment of the container securing arrangement.

FIGURE 3
Sample Bridge Fittings and Strut



3.3 Lashing Assemblies

Lashing assemblies are utilized to resist the overturning moment of a free standing stack of containers. Some of the ways that they can be applied are described in Section 5. Typically, they consist of a tension element (for example, steel rod, chain or wire rope), a tensioning device (for example, a turnbuckle), and a lashing point. The lashing point is a fixed securing device and is discussed in 4/5. Modern container lashing assemblies typically use a steel rod as the tension element.

The upper end of the lashing rod is designed to fit the openings in the container corner castings and to engage or secure the rod to the corner casting when rotated to the intended angle of application. As noted, they are commonly designed to only support tensile loads, not compressive loads. Slack is removed, and the assembly is tightened with a threaded element in the tensioning device. Repetitive container stack movements that occur in a seaway can cause the lashing assembly to alternate between slack and taut conditions. This may cause the tensioning device to loosen if not fitted with a locking device to prevent the threaded portion from backing off. The stiffness of the lashing assembly is an important factor in the load sharing between the lashings and containers.

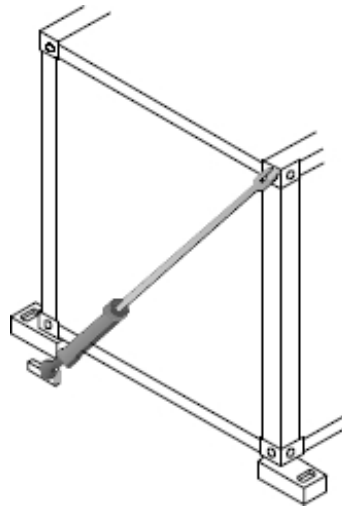

3.3.1 Tension Elements: Lashing Rods, Chain, Wire

Normally, high tensile steel is used to create rods that have the appropriate strength and length while remaining light enough for one person to handle. The end fittings must be easily installed in a corner casting several meters above the access platform and also mate with the tensioning device. Flexibility to handle containers of different heights (standard and hi-cube containers) can be provided with additional links or attachment points on the rod.

Chain and wire rope are not typically used on pure containerships because they are more difficult to install and maintain. They can, however, be useful for non-standardized cargo stowage arrangements.



3.3.2 Tensioning Devices (Turnbuckles)

Tensioning devices usually require an additional rod or tool to turn the barrel or body of the turnbuckle as it is tightened or loosened. It is important that it also be fitted with a locking mechanism to reduce the likelihood that lashing assemblies will slacken in a seaway due to the cyclical loading and unloading associated with the vessel's motions.

The maximum range of operation (minimum to maximum working length) is one of the primary factors determining the working length of the entire lashing assembly.



3.5 Stiffness of Loose Fittings

For the flexible securing devices (lashing assemblies and some bridge struts) the actual stiffness is critical to the proper analysis of the container securing system. The stiffness can be determined by properly designed and conducted tests, and in some cases, by calculation.

3.5.1 Stiffness Measurements

It is best to determine the spring constant (K_ℓ) of the entire securing assembly by testing. For lashing assemblies, the test shall include the fixed lashing point, tensioning device, and tension component assembled as it will be in service. The assembly shall be loaded up to its Safe Working Load (SWL) and measurements of strain taken at discrete points of load application (zero to the SWL). The lashing assembly spring constant will be the average slope of the load/strain curve.

3.5.2 Stiffness Calculation for Lashing Assemblies

When testing is not possible, the lashing assembly spring constant may be determined from the stiffness of the tension element (e.g., rod, chain, or wire).

$$K_\ell = \frac{A_\ell E_\ell}{L_\ell} = \text{lashing spring constant, in kN/mm (Ltf/in)}$$

where

- A_ℓ = cross-sectional area of a lashing assembly tension element, in mm² (in²)
- E_ℓ = equivalent elastic modulus of the lashing, in kN/mm² (Ltf/in²)
- L_ℓ = overall length of the lashing assembly measured from the securing point to the container corner casting attachment point (no deduction for tensioning device), in mm (inches). This length is to include the longitudinal separation of the lashing point and face of the container stack, unless this longitudinal separation is less than 400 mm (15.7 in.).

In the absence of submitted lashing test data, the values given in Section 4, Tables 1 and 2 may be used in the above expression.

TABLE 1
Area of Lashing Component, A_ℓ

<i>Lashing Element</i>	A_ℓ
Steel Wire Rope	Nominal area
Steel Rod	Actual area
Steel Chain	One side of link

TABLE 2
Equivalent Elastic Modulus, E_ℓ (1 February 2017)

<i>Lashing Element</i>	E_ℓ	
	<i>kN/mm²</i>	<i>Ltf/in²</i>
Steel Wire Rope	88.3	5,715
Steel Rod in lashing assembly with $L_\ell \leq 5000$ mm (197 in.) (for lashings extending up ~1 tier)	140.0	9,062
Steel Rod in lashing assembly with $L_\ell > 5000$ mm (197 in.) (for lashings extending up ~2 tiers)	176.6	11,430
Steel Chain	98.1	6,350

Lashing elements made of materials other than steel will be specially considered. Each wire rope lashing element is to be pre-stretched to remove its construction stretch by loading to 50% of its rated breaking strength before being placed in service.

3.5.3 Stiffness Calculation for Bridge Strut and Shoring

The spring constant of the bridge strut or shoring is expressed by the following equation.

$$K_s = \frac{T'}{\Delta s} \quad = \quad \text{strut or shoring spring constant, in kN/mm (Ltf/in)}$$

where

T' = bridge strut or shoring force applied, in kN (Ltf)

Δs = displacement of the bridge strut or shoring under load, T' , in mm (in)

5 Fixed Fittings

Securing devices that are permanently attached to the hull structure (including fittings attached to hatch covers) and that can not be removed for storage or maintenance are “fixed fittings”. In some cases, loose fittings (for example, lashing assemblies) are used between containers and the fixed fittings such as lashing plates. In other cases, fixed fittings provide support directly to containers, as is the arrangement with doubler plate foundations.

5.1 Foundations and Base Plates

These fittings are used under the corner castings and stacking posts of the containers. They support the entire compressive load from the stack and transfer it to the hull structure. In cargo holds with cell guides, these foundations can be simple doubler plates since they do not support any tension or shear load. Where there are no cell guides, but the stacks are restrained from tipping by bridge fittings and/or shoring fittings, the foundations will typically have centering cones or transverse guides between container stacks to take the shear or transverse load at the bottom of the stack. This keeps the bottom of the stack from sliding horizontally. In some cases (for example between 20-ft containers in a 40-ft cell), guide plates or “shear chocks” are used to restrain the free ends of the 20-ft containers from transverse movement as the vessel rolls.

FIGURE 4
Sample Foundation and Guide Fitting



5.3 Twistlock Foundations (Deck Sockets or Base Sockets)

When stacks are secured with flexible lashing assemblies and the container corners are to be restrained in tension as well as compression, twistlock foundations or “base sockets” are used. These fixed fittings have apertures designed for use with a twistlock that are similar to the apertures in the bottom of a container corner casting. Once the twistlock is engaged, the base socket can transmit the full allowable corner post tensile load into the hull’s structure. It is important that the top plate of the base socket be capable of taking the full MBS rating in tension through the small contact area of the ears of the twistlock that provide the restraint.

FIGURE 5
Sample Twistlock Foundations or “Base Sockets”

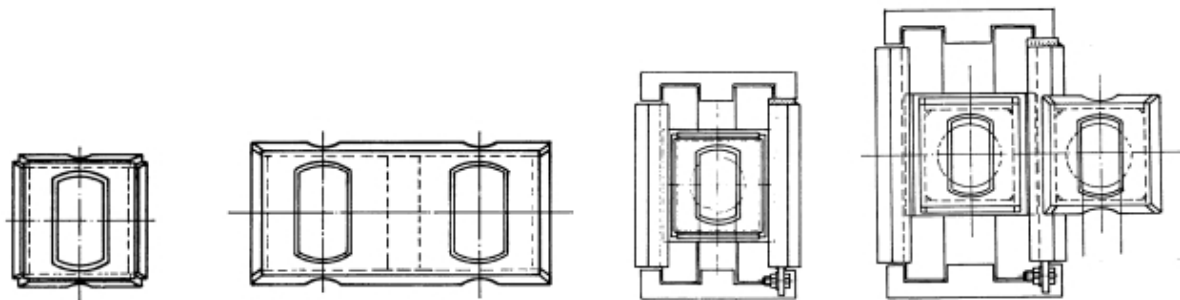

As seen from 4/5.3 FIGURE 5, base sockets are manufactured in single and double configurations. For locations where the containers must span hatch covers, or are supported partly on hatch covers and partly

on pedestals, sliding base sockets are often used. These allow relative movement in the underlying hull structure while still providing tension, transverse shear, and compression restraints.

Dimensional tolerances during installation shall ensure center-to-center distances as defined in Ref. 2 do not differ by more than the following:

Longitudinal	+0/-5 mm (+0/- ³ / ₁₆ in.)	for 10-ft containers
	+0/-6 mm (+0/-0.25 in.)	for 20-ft containers
	+0/-10 mm (+0/-0.375 in.)	for 30, 40, 45, 48, and 53-ft containers
Transverse	+0/-5 mm (+0/- ³ / ₁₆ in.)	
Difference in diagonals	< 13 mm (¹ / ₂ in.)	for 20-ft containers
	< 19 mm (³ / ₄ in.)	for 40, 45, 48, and 53-ft containers

Regarding the flatness of the base plane of a stack of containers created by four foundations, no point shall deviate from the plane of the other three by more than:

±3 mm (¹ / ₈ in.)	for 20-ft containers
±6 mm (¹ / ₄ in.)	for 40, 45, 48, and 53-ft containers

5.5 Lashing Plates and D-Rings

Lashing plates and D-rings are the connecting points for lashing assemblies to the hull structure. These fittings are welded to the deck, pedestals, lashing bridges, or hatch covers. The lashing plates and D-rings are to typically have a strength rating equivalent to or greater than the MBS of the lashing assembly and be aligned with the direction of the load. Some lashing plates have swivels to accommodate different stack configurations. D-rings offer the option of a low profile when not in use and are most common on open decks or in holds, where taller obstructions would be a problem.

FIGURE 6
Sample Lashing Points

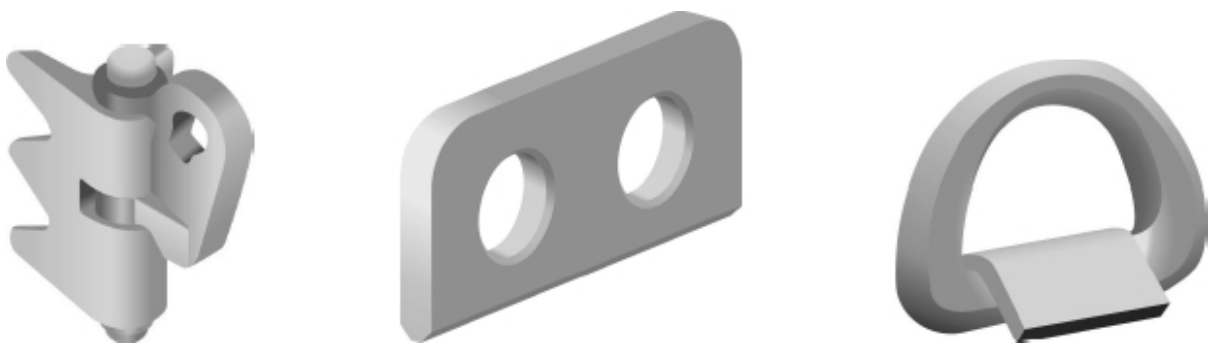

7 Strength Ratings and Factors of Safety

Each container securing device, whether loose or fixed, has an allowable strength rating referred to as the Safe Working Load (SWL). The calculated load in a container securing device subject to the accelerations and forces defined in Section 6, “Securing System Design Principles”, is not to exceed the safe working load (SWL). The SWL is defined as a function of the Minimum Breaking Strength (MBS) and a Safety Factor (SF) as discussed in 4/7.1 and 4/7.3.

The design strength limit for the attachment welds for fixed securing devices is covered in 4/7.5. For all container supporting elements, such as cell guides, lashing platforms, shoring, and buttresses, as well as related hull structure, the design limits are given in 6/7.7 and 6/7.9.

7.1 Safety Factors for Securing Devices

In order to account for such unpredictable factors as deterioration of securing devices, deterioration of containers, manufacturing imperfections, extreme ship motions, and variations in container and lashing spring constants, a safety factor is used to reduce the minimum breaking strength (*MBS*) of a device to an acceptable safe working load (*SWL*). The *SWL* is obtained by dividing the minimum breaking strength (*MBS*) of the element by the specified safety factor (*SF*).

$$SWL = \frac{MBS}{SF}$$

The safety factors shown in 4/7.1 TABLE 3 are to be used for all container securing devices.

TABLE 3
Safety Factors for Securing Fittings

<i>Lashing Element</i>	<i>Material</i>	<i>Safety Factor (SF)</i>
Steel Wire Rope	---	2.0
Steel Rod	MS HTS	2.0 1.67
Steel Chain	---	2.0
Other Steel Fittings and Securing Devices	MS HTS	2.0 1.67
Nodular Iron Fittings	---	2.0

MS = ordinary strength steel

HTS = higher strength steel with $f_y \geq 315 \text{ N/mm}^2$ (20.4 Ltf/in²)

7.3 Strength Ratings for Securing Devices

All securing devices are subject to factory testing to confirm the minimum breaking strength (*MBS*). This testing is described in Section 8, “Testing, Inspection and Approval of Securing Devices”. The manufacturer shall provide with each delivered order of fittings an ABS test certificate which confirms the *MBS* and *SWL*. The certified *SWL* is to be used to design the container securing system.

4/7.5 TABLE 4 shows nominal design values of mean breaking strength and safe working load that are in common use and is provided for reference.

7.5 Strength of Weldments for Fixed Securing Devices

The strength of weldments for lashing plates (padeyes), base sockets, and other fixed securing devices is governed by the permissible stress given below. The applicable load is the *SWL* of the device.

$$q = 0.53f_y$$

where





q = nominal permissible shear stress, in kN/cm^2 (Ltf/in^2)



f_y = minimum specified yield point of the weld filler material, in kN/cm^2 (Ltf/in^2)

For higher strength filler material, f_y is not to be taken as greater than 72% of the specified minimum tensile strength. Note that the strength of the weld filler material is not to be taken greater than the strength of the lowest strength base material to which the weld is attached.

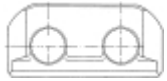
The structure supporting any securing device shall meet the design requirements of the hull structure. See also 6/7.9.

TABLE 4
Typical Design Load for Container Securing Fittings

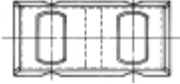
<i>Lashing Element</i>	<i>Min. Breaking Strength (MBS)</i> <i>kN</i>	<i>Safe Working Load (SWL)</i> <i>kN</i>	<i>Min. Breaking Strength (MBS)</i> <i>Ltf</i>	<i>Safe Working Load (SWL)</i> <i>Ltf</i>
Tension Element (Lashing Rod) 	490	293	49.2	29.4
Tensioning Device (Turnbuckle) 	490	293	49.2	29.4
Lock Fitting (Twistlock) 	500	299	50.2	30.0
Lashing Point (Lashing Plate) 	490	293	49.2	29.4
Lashing Point (D-Ring) 	460	275	46.2	27.6

<i>Lashing Element</i>	<i>Min. Breaking Strength (MBS) kN</i>	<i>Safe Working Load (SWL) kN</i>	<i>Min. Breaking Strength (MBS) Ltf</i>	<i>Safe Working Load (SWL) Ltf</i>
Twistlock Foundation (Base Socket) 	500	299	50.2	30.0
TP Bridge Fitting 	400	200	40.1	20.1

Container Securing Arrangements**1 General**

Containers are generally to be stowed above and below deck with their sides or longest dimension oriented in the fore-and-aft direction. Stowage in the athwartship direction is to be considered separately.

Containers shall not be stowed in locations above and below deck that preclude access for inspection and maintenance of equipment or systems required for safe operation of the vessel.

In general, containers shall not be stowed on deck beyond the sides of the vessel.

Container stacks may be secured with systems employing fixed and flexible restraints or combinations of both. A brief overview of typical container securing arrangements is given in this Section.

Maximum securing loads shall take into consideration the limits of the supporting vessel structure. Permissible loads and ratings for securing systems are dependent on the strength and flexibility of the securing components and the containers. The design principles and guidance for evaluating these systems is presented in Section 6.

3 Stacks Secured Only with Lock Fittings

Container stacks may be secured using only lock fittings (twistlocks) at all four corners between tiers and between the base sockets and the bottom corner castings. This system may be used for securing stacks with one or more containers depending on the location, accelerations, and the wind load (if located above the weather deck). Restraint against tipping is provided by locking devices at the base of each tier. Permissible stack weights are based on the vertical strength of the lock fittings and container corner posts, in tension and compression, and by the end wall racking strength of the containers.

5 Flexible Securing Systems (Lashings)

Container stacks may be secured using flexible lashing assemblies that are connected to fixed points at the deck, hatch cover, or elevated lashing platform and the openings in the container corner castings. The lashing assemblies may be used to provide vertical and/or lateral restraint. Lock fittings are also typically required in stacks secured with flexible lashing assemblies. This type of securing system is generally used for container stacks on the weather deck.

5.1 Typical Lashing Arrangements

Securing systems for deck stowage of containers are generally designed so that each stack is independent and may be loaded or unloaded without impact to the adjacent stack. The following Subparagraphs describe several common lashing arrangements.

5.1.1 Cross Lashing

A cross lashing system utilizes two lashing assemblies per end wall that lead across the end panels of the container stack in both directions. The lower end of a lashing assembly starts at a fixed securing point, such as a lashing plate, on one side and typically extends to the bottom corner casting of the second or third tier container above the lashing point at the opposite side. An example of a double cross lashed stack with both an upper and a lower cross lashing is shown in 5/5.1.5 FIGURE 1. Although both the upper and lower lashing assemblies provide lateral restraint, note that the steeper angle of the upper lashing renders the lashing less effective, while the vertical component of the restraining force contributes to the overall corner post compression load in the containers below. The upper cross lashing assembly, because of the length, is more awkward to handle and install.

5.1.2 Paired Lashing

A paired cross lashing arrangement is a double cross lashing in which the lashing assemblies run to the bottom corner casting of the upper tier and to the top corner casting of the lower tier. This arrangement is stiffer than a single cross lashing system and provides some measure of redundancy. A paired lashing system typically utilizes rods that are generally the same length.

5.1.3 Vertical Lashing

A vertical lashing assembly is used to resist the tipping moment and in particular, the vertical uplift load (corner post tension) on the uphill side of an inclined stack. These lashing assemblies are typically used at outboard wind loaded stacks. An example is shown in 5/5.1.5 FIGURE 2.

5.1.4 Side Lashing

A side lashing is similar to a cross lashing except that it leads away from the container stack instead of across the end face of the stack. Refer to 5/5.1.5 FIGURE 3. In addition to the lateral restraint provided, the vertical component of the restraining force from a side lashing helps to reduce corner post tension. However, it can not be applied to both sides of an outboard stack at the side of the vessel, and the lashing assemblies require special heads with suitable offsets to permit the lashing assemblies from adjacent stacks to cross over one another without interference.

5.1.5 Combination Lashing Systems

As shown in 5/5.1.5 FIGURE 2, it is possible to combine lashing systems for specific locations where their effectiveness may permit higher stack ratings. For example, outboard stacks that are subject to a lateral design wind load are often limited by corner post tension. The addition of a vertical lashing on the outboard side can enhance cargo stowage. Similarly, a single upper cross lashing may be combined with a paired cross lashing.

FIGURE 1
Typical Lashing Arrangements

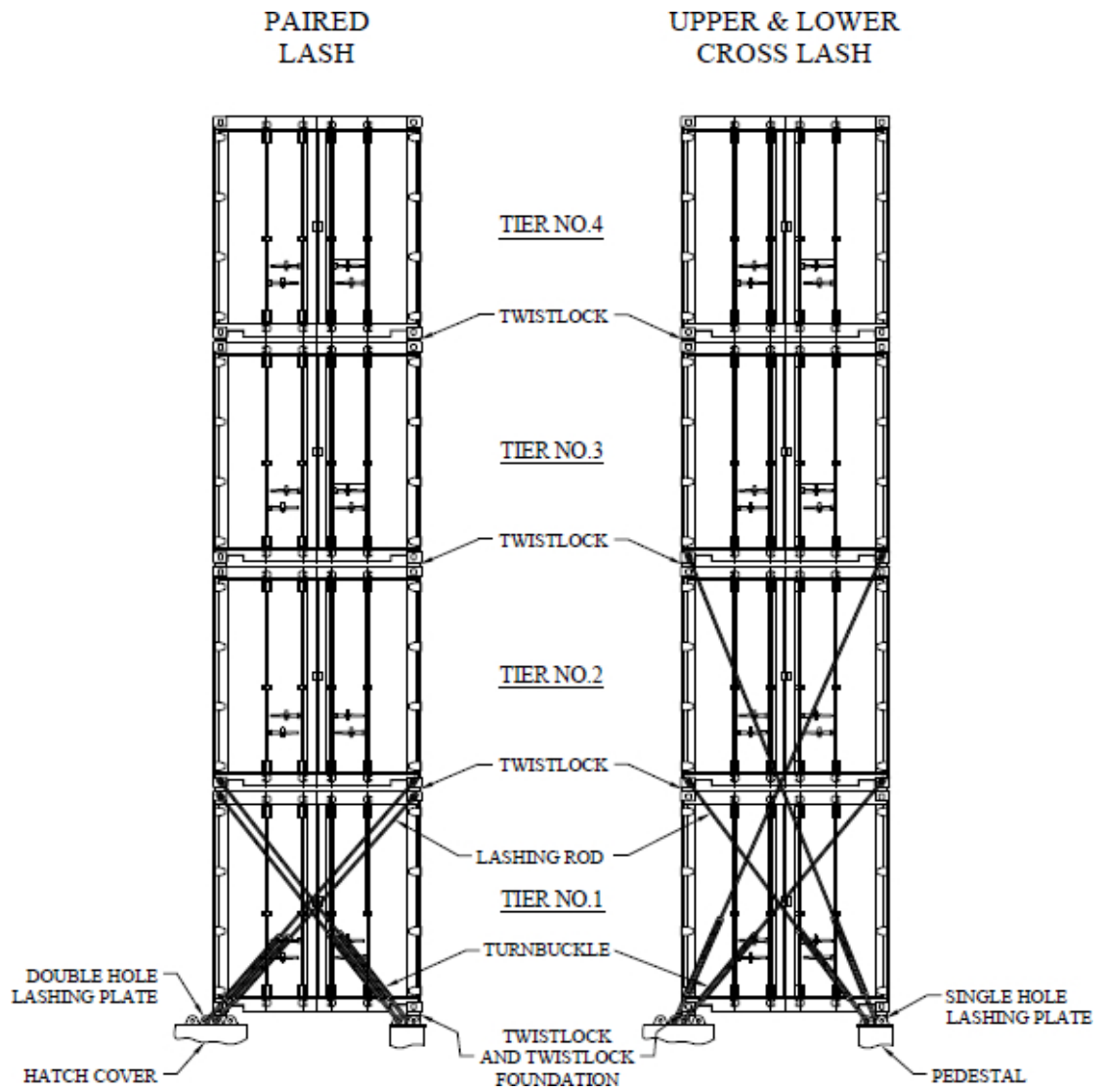

FIGURE 2
Combined Lashing Systems

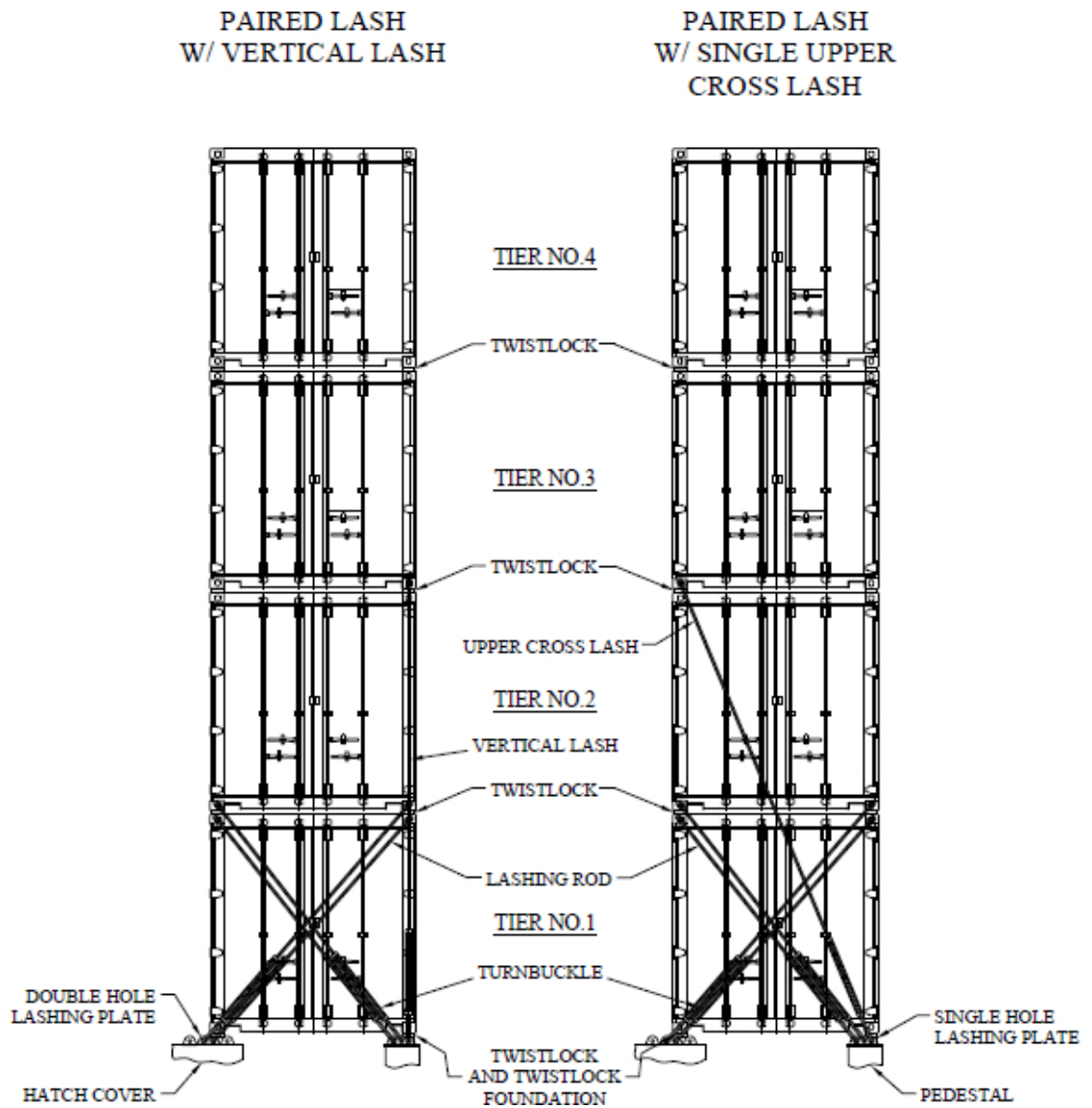
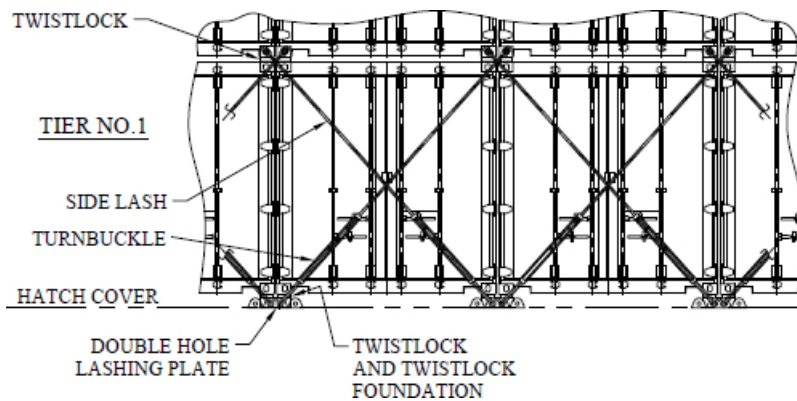

FIGURE 3
Side Lashing System



5.3 Raised Lashing Platforms (1 February 2017)

Flexible lashing systems are more effective when the horizontal restraining component can be applied at a higher point in the container stack. Because of their weight and size, long lashing rods are more difficult to handle and install. Long lashing assemblies have less stiffness, and due to the steeper angle of application, the resulting horizontal force is reduced. For these reasons, raised lashing platforms or lashing bridges are often used to increase container stack heights and weight when container arrangements are not constrained by vessel stability or visibility.

Raised lashing platforms, such as that shown in 5/5.3 FIGURE 4, offer the following benefits:

- Better lashing angles for shorter and more manageable lashing assemblies
- Higher allowable stack weights for given container and lashing assembly strength ratings
- Access to monitor and maintain reefer containers in lower tiers
- Options for handy stowage of rods and turnbuckles

FIGURE 4
Raised Lashing Platform

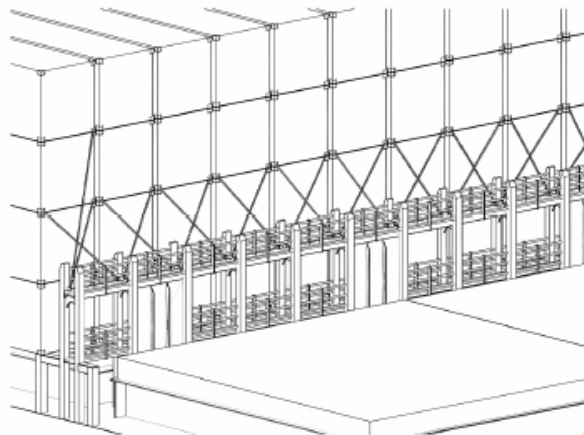

5.3.1 Design Considerations (1 December 2021)

The following points are to be considered when container stacks are lashed from raised platforms:

- The lashing assemblies are attached to lashing points on the raised lashing platform, which may move as part of the vessel's structure independent of the container stacks on the hatch covers. In a quartering seaway, torsional warping of the hull girder can result in relative movement between the container stacks and the lashing bridge. The resulting change in lashing tension may impact the effectiveness of the lashing assembly.
- Clearance is required between the hatch cover and the raised lashing platform to reduce the risk of impact with the platform when handling the cover, and also to accommodate the hatch cover and hull relative movements at sea. This increases the longitudinal lead of the lashing assembly and reduces the effective lashing angle in rolling mode.
- Lashing positions on raised lashing platforms are to have a clear working area and allow safe access and reach for the personnel using these platforms.
- Lashing from a raised lashing platform to a higher point on the container stack requires that the lashing assembly have a larger adjustment in length to suit potential variations in container height in the tiers below. Standard height and hi-cube containers differ in height by 305 mm (12 in). For a connection at the top of the 3rd tier, the differential could be as much as 915 mm (36 in).

Commentary:

Lashing platforms, which are often narrow by design, are inherently flexible in the fore-and-aft direction. Lashing platforms raised by more than two tiers high should be appropriately considered for structural vibration response in terms of resonance with operational excitation effects by the designer. The governing case is likely to be when containers are not attached to the lashing bridge (e.g., when the vessel will be empty for long periods or on sea trials).

End of Commentary**5.3.2 Strength Evaluation of Raised Lashing Platforms (1 December 2021)**

The global strength of a raised lashing platform is to be verified with the structural design loads determined either using the conditions in 5/5.3.2(a) and calculation procedure provided in Section 6 of this Guide, or based on 5/5.3.2(b) FIGURE 6. The structural design load cases are specified in 5/5.3.2(c). The assessment criteria are specified in 5/5.3.2(d) and 5/5.3.2(e).

The local strength assessment requirements of the raised lashing platform are specified in 5/5.3.2(f).

5.3.2(a)

For the global strength assessment, the maximum number of lashings used in typical arrangements is to be considered. Only regular 40' (40' × 8' × 8'6") containers need to be taken into account. Only the rolling mode described in 6/3 with a transverse GM value equal to 10% of the vessel's breadth needs to be considered. Wind loads do not need to be taken into account.

Lashing forces for the design of the lashing platform are to be calculated for a container stack with the maximum stack height and maximum stack weight according to the container stowage plan. Homogeneous container weight distribution (all containers assumed to be of equal weight) is to be applied. If any of the calculated loads for the containers, corner fittings, or securing devices exceed their permissible loads as indicated in 3/5, the container weight distribution is to be stratified (weights decrease in higher tiers) such that all of the permissible loads can be satisfied with the highest possible vertical center of gravity (VCG) for the container stack with the maximum weight. If the stack needs to be stratified in order to satisfy all of the permissible loads, the maximum ratio between the calculated and permissible loads is not to be less than 98% for the stratified stack.

In cases where neither the homogeneous nor the stratified distributions satisfy all of the permissible loads at the maximum stack height and weight, or the VCG of the stratified stack with the maximum stack height and weight is located lower than 40% of the maximum stack height from the stack bottom, the lashing forces are also to be evaluated for all potential reduced stack heights from the lowest possible through one tier less than the maximum height with the maximum stack weight of a homogenous distribution. The lowest possible stack height is defined as the higher height of the following stacks:

- i)** The stack with the lowest number of tiers with which the maximum stack weight can be achieved with a homogeneous distribution without exceeding the maximum weight of the containers,
- ii)** The stack with the lowest number of tiers which includes all of the lashing assemblies. If the highest lashing assembly is located at the top corner of a container, the stack is to include the container immediately above the highest lashing assembly.

For any of the reduced stack heights, if any of the calculated loads exceeds its permissible value, the stack weight is to be reduced while maintaining a homogeneous distribution such that either all of the permissible loads are satisfied or the lowest possible stack weight is reached. In such a case, the maximum ratio between the calculated and permissible loads is not to be less than 98% for the weight reduced stack.

The lashing force results of the stack(s), with either the maximum or a reduced stack height, that yield:

- The maximum net lashing force in the transverse direction, and
- The maximum lashing force produced moment about the baseline of the container stack

are to be selected as two independent sets of the lashing platform structural design loads and applied separately to the lashing bridge. If a stack cannot ultimately satisfy all of the permissible loads, it does not need to be considered in the determination of the structural design loads.

The procedural flowchart for the determination of the design loads is shown in 5/5.3.2(a) FIGURE 5.

FIGURE 5
Procedural Flowchart for Design Load Determination (1 February 2017)

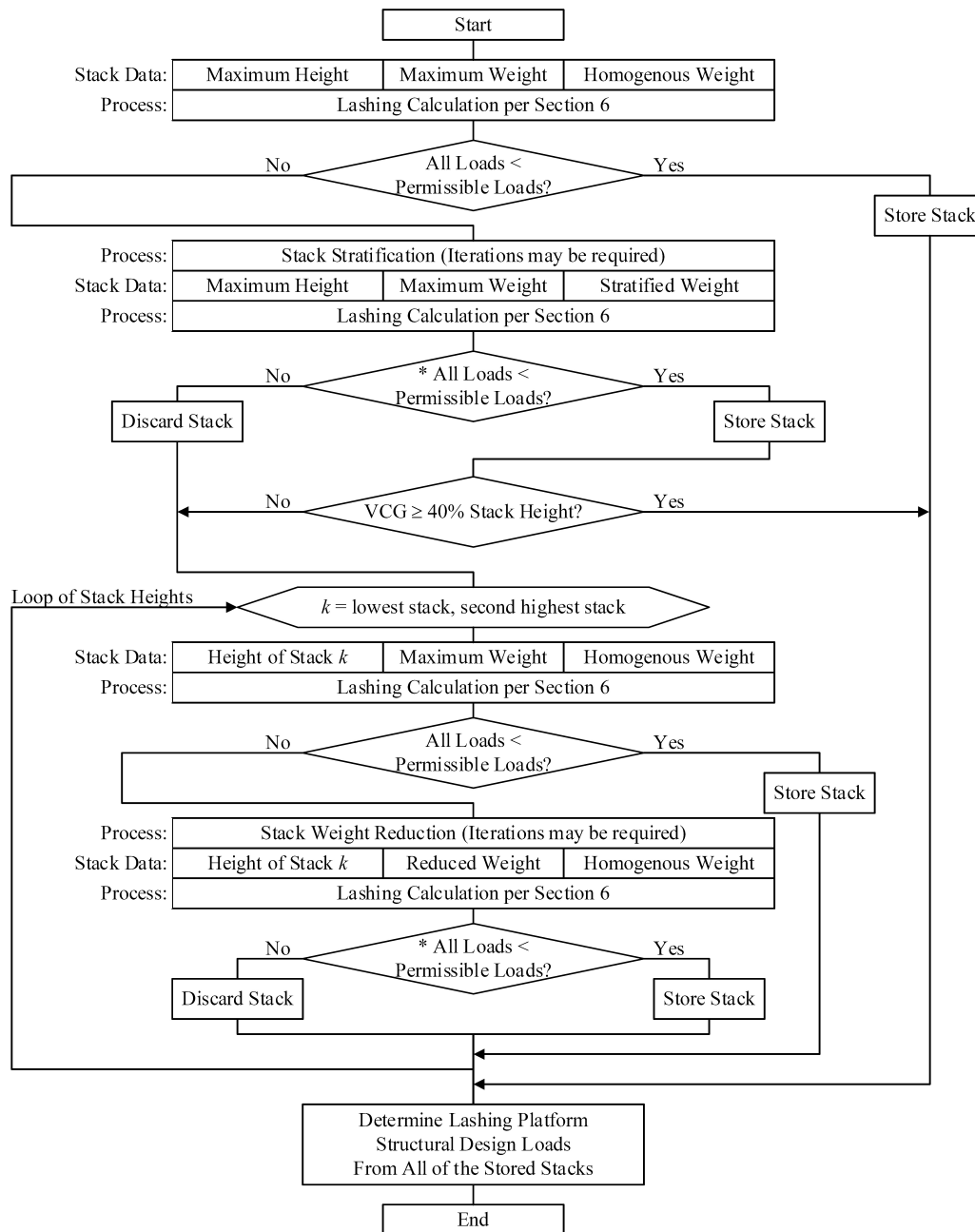

* The maximum ratio between the calculated and permissible loads is not to be less than 98%.

5.3.2(b)

Alternative to 5/5.3.2(a), the lashing forces used for global strength assessment of the lashing platform may be determined as the percentages of the lashing rod's SWL as indicated in 5/5.3.2(b) FIGURE 6.

FIGURE 6
Lashing Platform Structural Design Loads as Percentages of Lashing Rod SWL (1 February 2017)

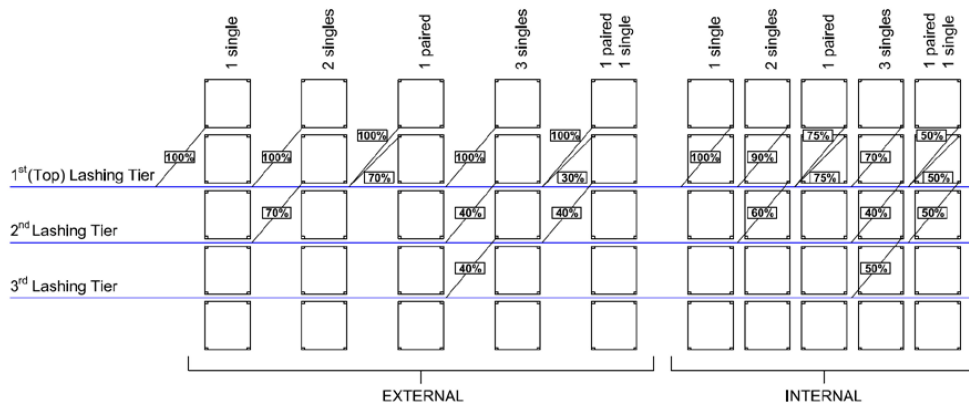

The loads determined based on 5/5.3.2(b) FIGURE 6 are to be imposed on the tension side lashing assemblies with the loads on the slack side lashing assemblies set to zero. The three labeled horizontal lines in the above figure represent the relative locations of up to three lashing assemblies on a lashing bridge, not necessarily the actual number of tiers of the lashing bridge.

ABS is to be consulted if the lashing arrangements differ from those specified in 5/5.3.2(b) FIGURE 6.

5.3.2(c)

In evaluating the structural design of raised lashing platform structures for global strength, the lashing platform design loads determined according to 5/5.3.2(a) or 5/5.3.2(b) are to be applied to the following design load cases separately:

- i)* The lashing platform design loads are to be applied at all of the lashing points in tension on both the forward and aft sides of the lashing platform.
- ii)* The lashing platform design loads are to be applied at all of the lashing points in tension only on the forward side of the lashing platform.
- iii)* The lashing platform design loads are to be applied at all of the lashing points in tension only on the aft side of the lashing platform.

5.3.2(d)

Evaluation of raised lashing platform structures for global strength may be performed using FE analysis or alternatively 3-D frame analysis. Gross scantlings without corrosion margin are to be used in the analysis. The acceptance criteria for both analysis types are stated below:

- i)* Where the 3-D frame analysis is used for raised lashing platform structure evaluation, allowable bending and shear stress limits are to be taken as $0.8Y$ and $0.53Y$, respectively, where Y is the minimum specified yield point of the construction material.
- ii)* Where an FE analysis is used for raised lashing platform structure evaluation, the mesh size is to be of a 150×150 mm representative uniform plating or based on lashing pillar section dimensions, whichever is smaller. The allowable von-Mises stress limit for such analysis is to be taken as $0.90Y$. When a finer mesh is used to represent critical areas of the raised lashing platform structure, the allowable von-Mises stress limit is to be specially considered depending on the extent and level of stress field.

For higher strength steels, Y is not to be taken as greater than 72% of the specified minimum tensile strength of the material.

5.3.2(e)

The buckling strength of the plated panels in a raised lashing platform (for example shear plates) is to be evaluated in accordance with Section 5C-5-5 of the *Marine Vessel Rules*.

5.3.2(f)

The local strength in way of lashing points, such as pad eyes and D-rings, is subject to the SWL of the lashing rod. For these purposes, the allowable von-Mises stress limit is to be taken as Y , where Y is the minimum specified yield point of the material. In way of the connections between pad eyes/D-rings and lashing bridge structures, where doubler plates are fitted on pillars in lieu of backing supports as an alternative, the following are to be observed:

- i) The thickness of a doubler in way of pad eyes/D-rings is to be twice the thickness of the plating it is attached to.
- ii) A doubler is to be sufficient in size so as to spread the load. The size of the doubler should generally be the same as the pillar dimension for a rectangular hollow section or flange width for an H or I beam.
- iii) A doubler's welded connection is to be designed to a safety factor of 2 on the SWL of the lashing rod with the weld profile ground smooth.

Other alternative supporting structural arrangements will be considered based on the submission of substantiating calculations such as FEA.

5.5 Containers Secured with Different Lashings Systems at Each End

When container stacks are secured with different systems at each end, permissible container stack weights are governed by the end with the least effective system, unless it can be shown through calculation that the more effective system can share a greater portion of the load. For example, if two stacks of 20-ft containers are stowed on a 40-ft hatch cover, the ends away from the middle of the hatch cover might be secured from elevated lashing platforms while the ends of the 20-ft containers at mid hatch are lashed to the top of the hatch cover. In this case, permissible stack weights are generally governed by the lashing arrangement used to secure the 20-ft containers at the middle of the hatch cover.

5.7 Relative Movement of Support or Securing Points

Due to their large hatch openings, containerships are susceptible to torsional warping of the hull girder in oblique seas. This results in some relative movement between the hatch covers and the hull structure or between two adjacent hatch covers. It is not recommended to arrange the containers such that they are sitting on two parts with different movements.

5.7.1 Containers Secured to Adjacent Structure

Container stacks stowed on a hatch cover may be lashed or secured to adjacent structure such as the hatch coaming or to an elevated lashing bridge. Depending upon the fore-and-aft lead of the lashing assembly and the estimated relative movement, the lashing arrangement shall be designed to accommodate this relative movement.

7 Cell Guides

A cell guide system consisting of vertical angles or Tees may be fitted in the cargo holds or on the weather deck to permit containers to be stacked vertically with no requirements for twistlocks or other portable securing fittings, see 5/7 FIGURE 7.

FIGURE 7
Typical Hold Cell Guide Arrangement

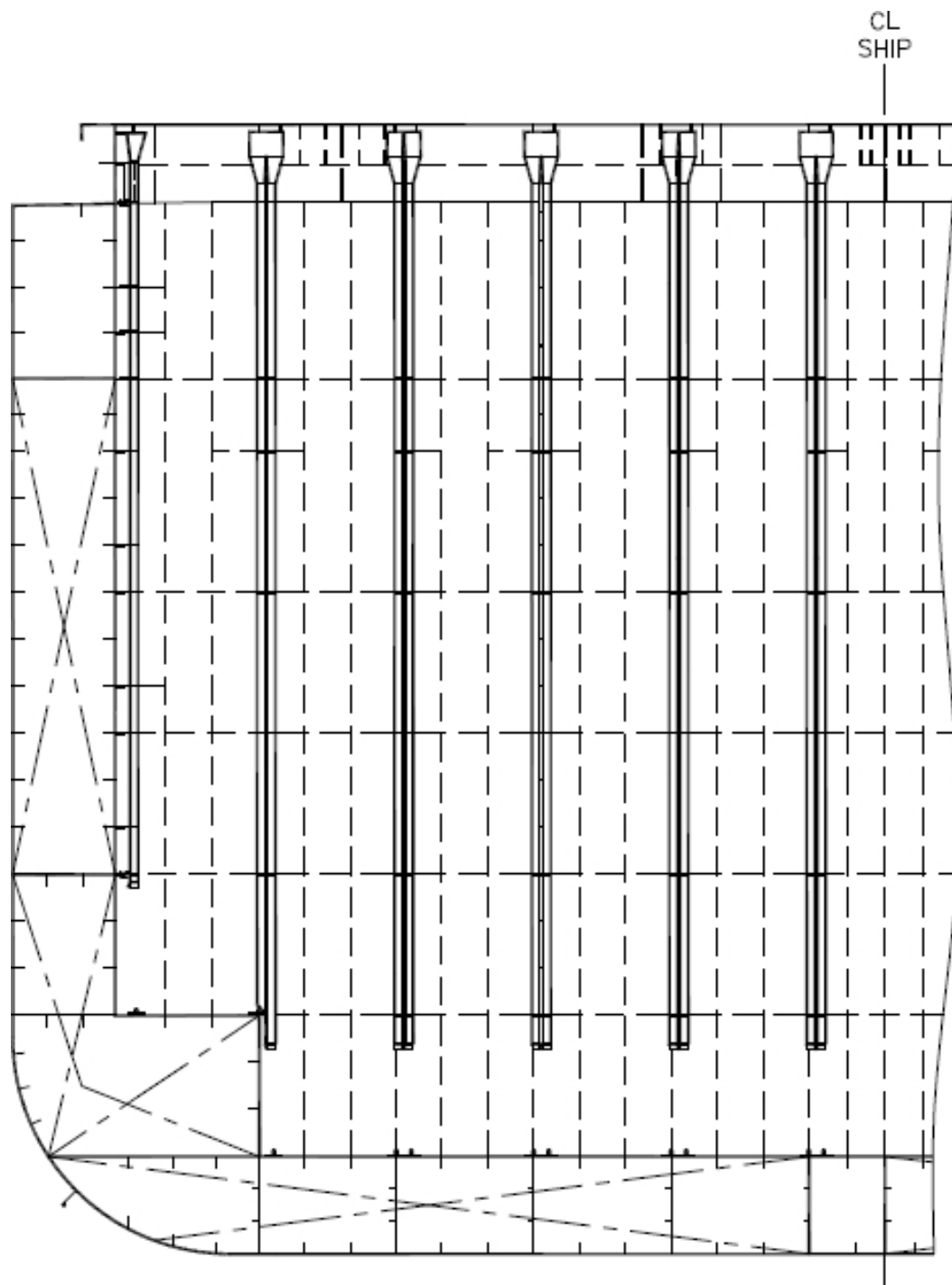

7.1 Design Considerations

The cell guides and associated support structure shall provide lateral restraint in way of the container corner post assemblies in both the fore-and-aft and transverse directions. Their design shall consider the horizontal accelerations presented in Section 6, as well as the operational loads associated with the container loading and discharge operations.

The inside faces of the cell guides experience abrasion and wear in service, which may lead to accelerated corrosion. The thickness of the cell guides shall not be less than 12 mm.

Maximum compression loads for the containers stacked within the cell guides are to be governed by the weight of the containers above and the design vertical accelerations presented in 6/3.7.

The top portion of the cell guides shall be designed to facilitate the entry process for loading containers or the crane spreader in a vertical cell and shall be robust in design and suitably reinforced to the vessel's structure for the impact loads that occur in this operation.

The cell guides are to be designed and fitted with controlled tolerances to ensure an even gap between the containers and the inside face of the guide. This will provide for smooth loading and discharge operations in normal conditions of trim and list. If the gaps are too large from poor control of tolerances, or the cell guides are bowed from damage in service, the potential to incur damage will be greater. It is recommended that the design gap or clearance between the inside face of opposing cell guides and the nominal container length and width does not exceed 38 mm in the fore-and-aft direction (lengthwise) and 25 mm transversely.

Support brackets and chocks shall be spaced at intervals to provide adequate support throughout the length of the cell for varying container heights and arrangements. Closer spacing of reinforcing structure is recommended in way of the entry guide and the section of cell guides just below this region since this is where damage occurs most frequently in operations.

7.3 Container Cell Guides at Only One End

Cell guides restrain transverse movement through contact with the corner post corner castings and are generally designed for stowage of one length of container. There are some exceptions for alternative stowage and two examples are discussed in the Subparagraphs below.

7.3.1 20-ft Containers within 40-ft Cell Guides

Since 20-ft containers are 1.5 inches (38 mm) short of 20 feet, there is room to stow two 20-ft containers within 40-ft container cell guides. Many containerships are designed for this alternate stowage arrangement. The fore-and-aft spacing between the two 20-ft containers will be 76 mm (3 in.) while still maintaining the standard clearance in way of the cell guides at both ends. In order to ensure that the first tier of 20-ft containers is correctly positioned within the 40-ft cell guides, some additional fittings should be installed at the base of the stack. In way of the 40-ft cell guides, centering cones are typically installed on top of the base plate to capture and correctly position one end of the 20-ft containers in the fore-and-aft direction. At the mid-hatch or "free" end of the 20-ft containers, transverse guides are typically installed between adjacent stacks to position the containers and to provide transverse restraint. See 5/7.3.1 FIGURE 8.

In order to maintain alignment and to transfer lateral loads to the containers below, at the free end, each tier is normally loaded using stackers. The permissible stack weights are typically limited by the racking strength of the bottom tier container at the free end. Since the mid-hatch end is not restrained above the base and is free to deflect, a larger share of the transverse load will be supported at the cell guide end due to the torsional rigidity of the containers. See 6/7.11 for the permissible stack weights for paired 20-ft container stowage. Note that paired 20-ft container stacks may be over-stowed with 40-ft containers and this arrangement ensures that the ends of the 20-ft containers in the uppermost tier remain within the shadow of the restraining cell guide.

FIGURE 8
20-ft Container Stowage in 40-ft Cell Guides

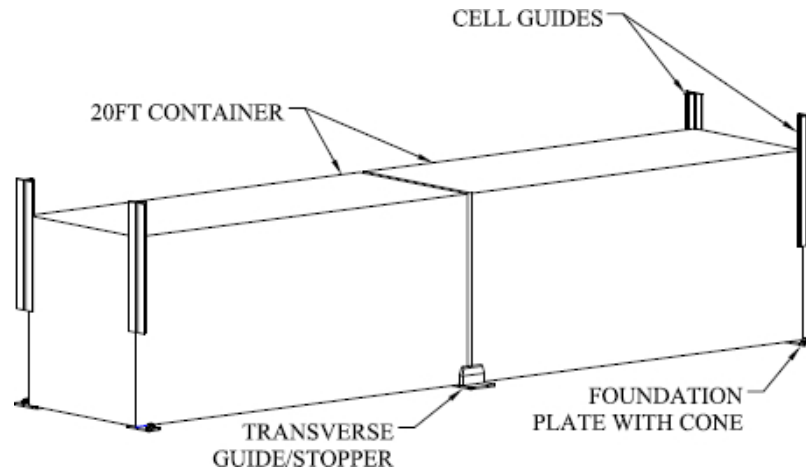

Due to the tolerance between the stacking fittings and the apertures in the bottom and top corner castings, there is the potential for the 20-ft containers in one stack to shift toward mid-hatch, reducing the overlap with the cell guide at the ends. A review of this tolerance shall be considered when determining how many tiers high paired 20-ft containers may be stowed without over-stowing with a 40-ft container.

7.3.2 40-ft Containers within 45-ft Cell Guides

Alternate stowage of 40-ft containers within 45-ft cell guides requires that similar fittings be installed at the base of the stack to guide and position the bottom container. Due to the longer length of the 40-ft containers, the portion of the lateral load restrained at the cell guide end in excess of 50% would have to be determined by calculation. The free end of the 40-ft stack could be accessed and it may be possible to secure this end with locking fittings and lashings. Maintaining the overlap within the cell guides at one end is more difficult since the 40-ft containers can not be over-stowed like the paired 20-ft containers. As fore-and-aft accelerations generally cause stacks to shift forward, utilization of the forward 45-ft cell guides is generally preferred.

9 Systems Combining Flexible and Rigid Elements

Container securing systems combining flexible and rigid elements shall be specially considered. In general, the element providing the lowest stack weights shall govern, except where it can be shown that the stiffer, rigid element can support a greater portion of the restraining load.

A common example of a securing system combining both rigid and flexible securing elements is an arrangement where one end of a container stack is restrained within fixed cell guides and the other end is secured with twistlocks or with a standard lashing system.

11 Other Fixed or Rigid Securing Systems

Buttresses and shoring systems are other structures fixed to the vessel that support transverse and longitudinal loads from the containers stacks. They can be hinged, lift on/lift off, or otherwise moveable frames that engage all or part of each tier in a stack of containers. When so configured, they do not assist with loading and discharge to guide containers into place.

Rigid securing systems other than cell guides shall be considered separately. Such systems may offer enhanced stack ratings or reduced stevedoring costs but also impose special stowage restrictions. Systems, such as a stacking frame and tower system or a hinged stacking frame and tower system, require that all containers in each tier be the same height and therefore reduce stowage flexibility.

13 Block Stowage of Containers

Block stowage, which is more prevalent on vessels other than cellular containerhips, entails securing a number of adjacent stacks to each other at one or more levels. Shoring or lateral restraint is provided in way of the corner castings at these same levels, at the outboard sides of the combined stack. These restraints reduce racking and compressive loads into the containers and prevent tipping. Rows of containers are stacked in close proximity with a set transverse spacing to facilitate connecting the containers and container stacks. In this way, the block of containers is restrained as a unit. First tier containers are positioned and laterally restrained with stacking cones or lock fittings at the base. Additional tiers are typically stowed utilizing stacking cones to maintain alignment. At specific tiers, adjacent stacks may be connected with double stacking cones. Inboard and outboard of the container block stowage shoring shall be used to provide lateral restraint at these levels. A prerequisite is that the same container height at each level is maintained for all containers stowed in that tier. The tops of the uppermost tiers of containers are connected using bridge fittings. At both sides of the block of containers, lateral restraint is typically provided utilizing bridge struts.

The bridge struts and shoring devices may be permanently attached, hinged or portable type and either flexible or rigid.

Hydraulically operated fold-down hinged chocks are sometimes used when containers are block stowed in open hatch forest product type vessels. The chocks fold down between specifically spaced rows (stacks) of containers to provide transverse restraint at different levels to blocks of containers stacked with twistlocks or stacking cones and bridge fittings to connect adjacent stacks at the top.

15 Stacks of Mixed Length and Width

Containers that are longer and wider than standard ISO 40-ft containers have been introduced to maximize the volume of the containers in integrated rail and trucking transport operations. Stowage and securing of such containers requires that base support points be provided on the vessel for each unique length and width. However, the demand and throughput may not warrant dedicated space for these unique containers as a fixed design would limit a vessel's flexibility and deployment in other services. Since below-deck stowage on cellular containerhips utilizes a rigid cell guide system which offers limited flexibility for alternate stowage, longer containers and especially over-wide containers are typically stowed above deck. Hatch openings and hatch covers designed for 40-ft container stowage below deck may not permit stowage directly on the hatch covers for containers longer than 40-ft. Containers such as 48-ft and 53-ft containers shall therefore extend to support points on pedestals or adjacent hatch covers. On larger containerhips with elevated lashing platforms, it may not be possible to stow the longer containers in the first, second or even third tiers on deck.

Containers longer than a standard ISO 40-ft container are typically fitted with corner posts and castings at the 40-ft points. Note that the transverse spacing of the aperture openings in the castings for lifting or vertically stacking the containers is based on the ISO standard. Refer to 3/3 TABLE 2. This design feature allows the longer containers to be stacked above a standard 40-ft container with an equal portion of the container extending beyond at both ends. In the case of 48-ft and 53-ft containers, which are wider (2.591 m or 8'-6") as well, they may also extend roughly 76 mm (3 inches) on each side. This presents some unique considerations when stowing 48-ft containers and 53-ft containers above 40-ft containers:

- The internal 40-ft corner posts of 48-ft containers and 53-ft containers are narrow by design to maximize and facilitate cargo stowage within the container. As the container corner castings are spaced per ISO standards for 8-ft wide containers, a couple or moment is introduced through the bottom structure of the over-wide container and into the twistlock and top of the 40-ft container directly below.
- 40-ft containers rows are typically spaced transversely with approximately 25 mm clearance between stacks to enhance stowage and loading. In this case, the over-wide containers may only be stowed above the 40-ft containers in every other stack.

- In some stacks, the longer 48-ft or 53-ft containers is to be secured to the container below using twistlocks at the end corner castings. The lowest 48-ft or 53-ft container shall be capable of supporting the load of the containers above and to pass that load in shear and bending through the side walls of the container to the 40-ft container below.

Options for securing over-wide containers and containers longer than 40 ft in length are often unique and shall be specially considered. In general, flexible lashing assemblies are not to be applied to the ends of the overhanging containers.

SECTION 6 Securing System Design Principles

1 General

The forces acting on the containers and the loads on the container securing systems are to be determined for all conditions of operation. If the operating and sea conditions for a specific service are known and the vessel response data determined by calculation, then the forces and loads may be specially considered. If, however, the vessel is intended for unrestricted service, then the forces and loads acting on the containers are to be determined using the method described in this Section. In turn, the securing systems and associated vessel support structure shall be evaluated for these loads in order to determine the operation envelope of the container stacking arrangement.

3 Design Loads

3.1 General

The basic loads to be taken into account in container securing calculations include gravitational forces, dynamic forces associated with ship motions, wind forces, and lashing or other securing forces.

Sea loads and green water impact are not explicitly considered in the securing system design criteria. Adequate protection from green water impact shall be provided.

3.3 Wind Loads

3.3.1 Wind Load (1 December 2023)

Wind forces are to be applied to exposed containers for the minimum vertical acceleration case in Condition A (6/3.7.1).

The wind pressure, P_w , shall be taken as:

$$P_w = 1.08F_w \cos^2 \theta \quad \text{kN/m}^2 \quad (0.0101F_w \cos^2 \theta \quad \text{Ltf/ft}^2)$$

where

θ = the roll angle, as defined in 6/3.5.2, but is not to be taken as greater than 18.5 degrees.

F_w = correction factor for wind pressure.

The flowchart for F_w determination is shown in 6/3.3.1 Figure 1. The container stack arrangement is shown in 6/3.3.1 Figure 2.

The wind load is assumed equally distributed over the side of the container. The vertical center of pressure is to be taken at the mid height of the container, and the longitudinal center of pressure is to be taken at the mid length of the container.

FIGURE 1
Flowchart for F_w determination (1 December 2023)

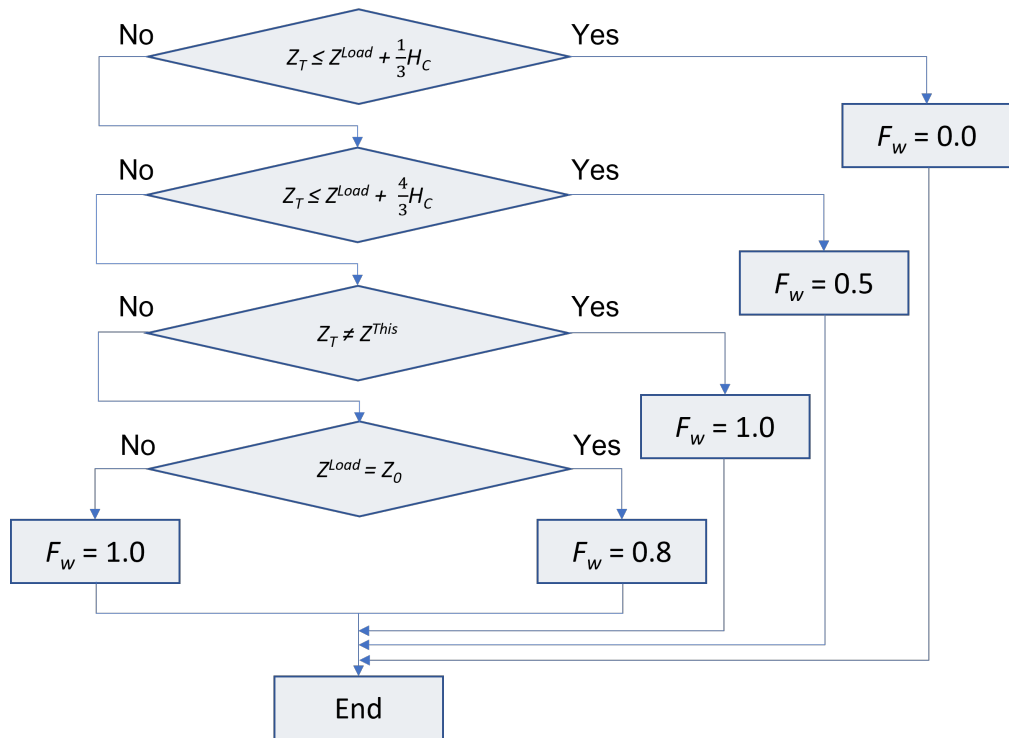

Z_T = vertical location of the top of this container (i.e., the container under consideration for F_w measured from the baseline)

H_C = height of this container, not to be taken less than 2.591 m (8.5 ft) or more than 2.896 m (9.5 ft)

Z^{Load} = vertical location of the highest top of the load side stacks with a clearance not exceeding 5 meters from this stack. Where there are no load side stacks within the 5 meters of clearance, Z^{Load} is to be set at the bottom of the ship, denoted by z_0 , if the ship side is within 5 meters of the load side of this stack, and at the bottom of the stack otherwise.

Z^{This} = vertical location of the top of this row (i.e., the row containing this container)

FIGURE 2
Container Stack Arrangements and F_w Values (1 December 2023)

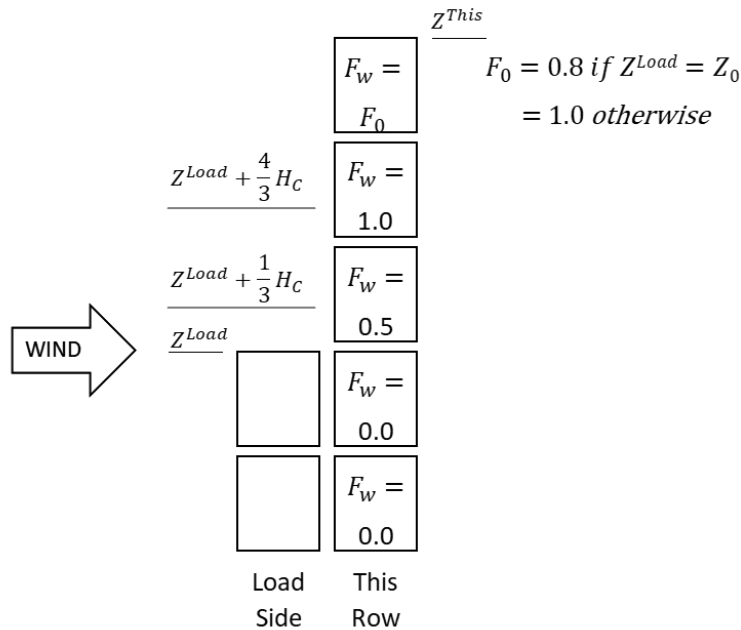

3.3.2 Fully Exposed Outboard Stacks

The wind load shall be applied to all containers in an outboard, unprotected stack.

3.3.3 Partially Protected Stacks

Any container with more than one-third of its lateral area exposed to the wind, either above the top or beyond the ends of adjacent containers or with 5 meters (roughly two container widths) or more transverse separation from an adjacent container stack, shall be considered an exposed container, and the wind load is to be applied over the entire lateral area of the container. When less than one-third of the lateral area is exposed, the wind effect may be ignored.

3.3.4 Inboard Stacks with Adjacent Stacks Empty

Where the clearance to containers in the adjacent stack exceeds 5 m (16.4 ft) on one or both sides, a container shall be considered exposed to the weather and the wind load shall be applied over the entire lateral area of the container stack.

3.5 Design Ship Motions

For service without restrictions, the accelerations and loads on containers are to be determined from the ship motions.

The formulas for ship motions and accelerations assume that parametric rolling is avoided, either through design or through vessel operations. For more information on parametric rolling, see the *ABS Guide for the Assessment of Parametric Roll Resonance in the Design of Container Carriers*. In particular, these formulas do not account for the extreme roll motions and simultaneous occurrence of extreme roll and pitch induced accelerations that may occur in head sea parametric rolling.

3.5.1 Ship Conditions

- GM = transverse metacentric height for the actual load condition, in m (ft). Where calculations are carried out for representative conditions for presentation in the Cargo Securing Manual, GM values should be evaluated over the expected operating range.
- d = draft to the summer load line, in m (ft)

3.5.2 Ship Motions

3.5.2(a) Roll Motion. (1 May 2024)

The natural roll period (full cycle) is to be obtained from the following equation:

$$T_R = \frac{2\pi k_r}{\sqrt{gGM}} \text{ sec}$$

where

k_r = roll radius of gyration, in m (ft), and may be taken as $0.40B$

g = gravity acceleration, in m/s^2 (ft/s^2)

GM = transverse metacentric height, in m (ft)

For the roll period calculation, the free surface effects due to anti-rolling tanks are not to be included in GM correction. This exclusion is only limited to the roll period calculation.

The roll angle (single amplitude) is to be obtained from the following equation:

$$\theta = \frac{3150C_{BK}C_{ART}}{k_u B + 75} \text{ deg}$$

where

k_u = $9.81/g$

B = molded breadth of the vessel, in m (ft)

For vessels with bilge keels

C_{BK} = factor for bilge keels

C_{BK} = $k_{large_BK} * 0.75$ if $T_R \geq 18$ sec

C_{BK} = $k_{large_BK} * [0.75 + 0.10(18 - T_R)]$ if $T_R < 18$ sec, but need not be taken greater than 0.90

k_{large_BK} = 0.9, if the vessel is equipped with bilge keels of 0.8 m (2.6 ft) or larger in height,

= 1.0, if the bilge keels are equal to or less than 0.4 m (1.3 ft) in height.

= Linearly interpolated if the bilge keels are between 0.4 m (1.3 ft) and 0.8 m (2.6 ft) in height.

= 1.0, if C_{ART} is applied ($C_{ART} < 1.0$)

For vessels without bilge keels

C_{BK} = 1.0

For vessels with active stabilizing systems, C_{BK} may be specially considered.

For vessels with anti-rolling tanks

For vessels with anti-rolling tanks (ART), the reduction of roll motions due to anti-rolling tanks may be considered based on the following factor:

$$C_{ART} = \frac{\theta_{with_ART}}{\theta_{no_ART}}$$

where

- C_{ART} = roll angle factor for roll due to ART
 = 1.0, for vessels without ART
 = 1.0, if the large bilge keel factor is applied ($k_{large_BK} = 0.9$)
- θ_{with_ART} = most probable extreme roll angle with ART from direct calculations under selected loading condition (without parametric roll situation)
- θ_{no_ART} = most probable extreme roll angle with no ART from direct calculations under selected loading condition (without parametric roll situation)

C_{ART} is not to be less than 0.8.

The operational guidance of the ART is to be submitted for ABS review. The most probable extreme roll angles with and without ART are to be obtained based on the following conditions:

- Loading conditions are to be considered based on the operation profile.
- Ship speed: 75% of the design speed
- Wave data: North Atlantic (e.g., IACS Recommendation 34, Rev 1 or 2)
- Return period: 20 years.

Commentary:

It is recommended to have three or more loading conditions with low GM, medium GM, and high GM, with different drafts.

Depending on the loading condition, different C_{ART} can be used.

End of Commentary

The nonlinear behavior of roll damping of the vessel, including the effects of ART and other devices, is to be considered for calculations. The roll damping data is to cover a broad range of roll angles, including large roll angles which are expected in severe sea states. The evaluation of roll damping data with and without ART as performed by a recognized facility or consultant is to be submitted for ABS review.

Commentary:

An iterative procedure is recommended such that the damping is reasonable for the expected roll motion in a specific sea state.

A recommended procedure for the ART factor is as follows:

- 1 *Vessel's Roll Damping with ART.* Evaluate the roll damping characteristics of the vessel with the effects of ART. This can be done by model tests, numerical analyses, or the combination of both. The effects of other roll reducing devices, such as bilge keels or fins, are to be considered as well. The roll damping is to be evaluated for the proper range of roll angles including large roll motions.
- 2 *Short-Term Analysis.* For each sea state in the North Atlantic wave scatter diagram (e.g., IACS Recommendation 34), calculate the response amplitude operator (RAO) of the roll motion, based on the roll damping for the corresponding roll amplitude in the sea state. An iterative process may be required to take into account the nonlinearity due to the ART.
- 3 *Long-Term Analysis.* Based on the short-term analysis results, compute the most probable extreme value of the roll angle considering the probability of the sea states and the wave headings in increments of 15 deg. For the wave headings, an equal probability of main wave headings may be assumed.

- 4 *Compute the ART Factor.* For the case without ART, use the same steps excluding the ART to compute the baseline most probable extreme roll angle. Then, calculate the ART factor using the roll angles with and without ART.

End of Commentary

For vessels with both large bilge keels and ART, only one of the factors, either the large bilge keel factor (k_{large_BK}) or the ART factor (C_{ART}), is to be applied.

The roll center, R_{CTR} , is to be taken at the vertical center of gravity of the vessel, measured in m (ft) above baseline. When the calculated vertical center of gravity of the vessel is not submitted, R_{CTR} may be estimated from the following formula:

$$R_{CTR} = \frac{D}{4} + \frac{d}{2} \text{ m (ft) above baseline}$$

where

D = molded depth at side, m (ft)

d = draft as defined in 6/3.5.1

3.5.2(b) *Pitch Motion.* The natural pitch period (full cycle) is to be obtained from the following equations:

$$T_P = 7 + 0.0123 \times (k_u L - 183) \text{ sec}$$

The single pitch amplitude to be taken as:

$\phi = 7$ deg where $L \leq 120$ m ($L \leq 394$ ft)

$\phi = 6$ deg where $120 \text{ m} < L < 275 \text{ m}$ ($394 \text{ ft} < L \leq 902 \text{ ft}$)

$\phi = 5$ deg where $L \geq 275$ m ($L \geq 902$ ft)

where

L = length between perpendiculars, in m (ft)

The pitch center of the vessel P_{CTR} is to be taken at the longitudinal center of flotation. When the calculated longitudinal center of flotation is not submitted, P_{CTR} may be estimated as $0.45L$ forward of the aft perpendicular.

3.7 Accelerations (1 April 2021)

Containers and their securing systems shall be capable of withstanding the forces generated by the following load combinations for unrestricted service:

Condition A: The maximum roll condition generating maximum across-the-deck accelerations, expected in quartering stern or beam seas.

Condition B: The maximum pitch condition generating maximum normal-to-deck accelerations, expected in head or near head seas.

The designer is to ensure that the stowage system satisfies all of the strength criteria for both Condition A and Condition B accelerations. For conventional lashing bridge designs with a height of up to 4 tiers for interior stacks or 5 tiers for wind exposed stacks and containers secured using only lock fittings on deck, Condition B need not be evaluated. For containers stowed in cell guides, corner post compression in

Condition B governs and Condition A need not be evaluated provided that the requirements of 6/7.11 are complied with for 20-ft containers in cell guides designed for 40-ft containers. For non-standard containers and other securing configurations, including block stowage in the holds of bulk carriers, Condition A and Condition B are to be evaluated.

The following definitions apply to both the Condition A and the Condition B load combinations:

- x_C = longitudinal distance to the center of gravity of the container, in m (ft), forward of the aft perpendicular
- $|x_C - P_{CTR}|$ = absolute value of the longitudinal distance from the vessel's pitch center to the center of gravity of the container, in m (ft)
- y_C = transverse distance to the center of gravity of the container, in m (ft), from the vessel's centerline
- $|y_C|$ = absolute value of the transverse distance from the vessel's centerline to the center of gravity of the container, in m (ft)
- z_C = vertical distance to the center of gravity of the container, in m (ft), from the vessel's baseline
- $|z_C - R_{CTR}|$ = absolute value of the vertical distance from the vessel's roll center to the center of gravity of the container, in m (ft)

FIGURE 3
Forces Due to Gravity and Ship Motions

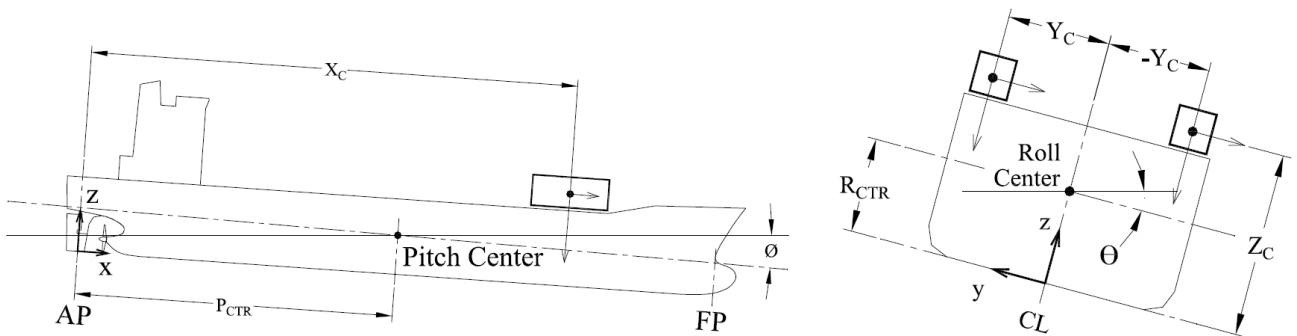

- a_0 = common acceleration parameter, in g's
 - = 0.2012 for $B \leq 32.2\text{m} (B \leq 106\text{ft})$
 - = $0.2012 + (0.0618\sqrt{k_u GM} - 0.2125)(k_u B - 32.2)/7.8$ for $32.2\text{m} < B < 40\text{m}$
($106\text{ft} < B < 131\text{ft}$)
 - = $0.1407 + 0.0618\sqrt{k_u GM} - 0.0038k_u B$ for $B \geq 40.0\text{m} (B \geq 131\text{ft})$
 - = a_0 is not to be taken less than 0.0
- k_C = 0.0701 for $x_C, y_C,$ and $z_C,$ in m
 - = 0.0214 for $x_C, y_C,$ and $z_C,$ in ft
- k_3 = force factor accounting for longitudinal position of container stack, where
 - = $0.5 \times \left(\frac{0.2L - x_C}{0.2L}\right)$ for $x_C < 0.2L$

$$= 0.0 \quad \text{for } 0.2L \leq x_C \leq 0.7L$$

$$= 0.7 \times \left(\frac{x_C - 0.7L}{0.3L} \right) \quad \text{for } x_C > 0.7L$$

FIGURE 4
Distribution of Force Factor k_3

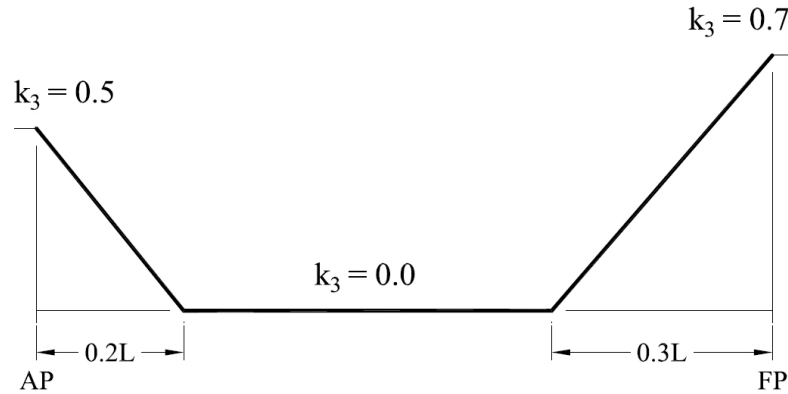

3.7.1 Condition A - Roll and Heave

The transverse and vertical accelerations at any point are to be obtained from the following formulas. The longitudinal accelerations are taken as zero for this condition.

The transverse acceleration is obtained from the following equation:

$$A_T = a_{GT} + k_C a_{RT} + (1 + k_3) a_0 \sin \theta \text{ in g's}$$

The maximum vertical acceleration is obtained from the following equation:

$$A_{VMAX} = a_{GRV} + k_C a_{RV} + (1 + k_3) a_0 \cos \theta \text{ in g's}$$

The minimum vertical acceleration is obtained from the following equation:

$$A_{VMIN} = a_{GRV} - k_C a_{RV} + (1 - k_3) a_0 \cos \theta \text{ in g's}$$

A_{VMIN} is not to be taken greater than 1.0

where

$$a_{GT} = \text{transverse static gravitational acceleration component, in g's}$$

$$= \sin \theta$$

$$a_{RT} = \text{transverse roll acceleration component, in g's}$$

$$= \frac{\theta}{T_R^2} |z_C - R_{CTR}|$$

$$a_{GRV} = \text{vertical static gravitational acceleration component, in g's}$$

$$= \cos \theta$$

$$a_{RV} = \text{vertical roll acceleration component, in g's}$$

$$= \frac{\theta}{T_R^2} |y_C|$$

3.7.2 Condition B - Pitch and Heave

The longitudinal and vertical accelerations at any point are to be obtained from the following formulas. The transverse accelerations are taken as zero for this condition.

The longitudinal acceleration is obtained from the following equation:

$$A_L = a_{GL} + k_C a_{PL} + a_0 \sin \phi \quad \text{in g's}$$

The maximum vertical acceleration is obtained from the following equation:

$$A_{VMAX} = a_{GPV} + k_C a_{PV} + a_0 \cos \phi \quad \text{in g's}$$

The minimum vertical acceleration is obtained from the following equation:

$$A_{VMIN} = a_{GPV} - k_C a_{PV} + a_0 \cos \phi \quad \text{in g's}$$

A_{VMIN} is not to be taken greater than 1.0

where

$$\begin{aligned} a_{GL} &= \text{longitudinal static gravitational acceleration component, in g's} \\ &= \sin \phi \end{aligned}$$

$$\begin{aligned} a_{PL} &= \text{longitudinal pitch acceleration component, in g's} \\ &= \frac{\phi}{T_P^2} |z_C - R_{CTR}| \end{aligned}$$

$$\begin{aligned} a_{GPV} &= \text{vertical static gravitational acceleration component, in g's} \\ &= \cos \phi \end{aligned}$$

$$\begin{aligned} a_{PV} &= \text{vertical pitch acceleration component, in g's} \\ &= \frac{\phi}{T_P^2} |x_C - P_{CTR}| \end{aligned}$$

3.7.3 Accelerations for Route-Specific Trade (1 April 2021)

For typical route-specific trades, the transverse accelerations A_T obtained for Condition A, for unrestricted service in 6/3.7.1, can be reduced by the following route-specific reduction factors. Maps of the typical route-specific trades are shown in Appendix A2.

	<i>Route</i>	<i>Reduction Factor</i>
0	Unrestricted	1.00
1	Asia - Europe	0.87
2	Pacific - Atlantic	0.96
3	North Pacific	0.95
4	North Sea - Mediterranean	0.94
5	North Atlantic	1.00
6	Asia - South America (West Coast)	0.95
7	South America (East Coast) - Africa	0.73
8	Africa - East Asia	0.86

	<i>Route</i>	<i>Reduction Factor</i>
9	Europe (Rotterdam) - Africa	0.90
10	Europe (Rotterdam) - South America (Brazil)	0.90
11	US (NYC) - South America (Brazil)	0.73
12	Northeast Asia - Australia	0.87

As an alternative to using the above reduction factors for the listed trade routes, or for trade routes not listed in the table, accelerations may be obtained by direct calculations according to 6/3.9.

The route-specific approach is not meant as a substitute for the independent judgment of the master and crew.

3.7.4 Accelerations for Short Voyages (1 August 2019)

Transverse accelerations A_T obtained for Condition A, for unrestricted service in 6/3.7.1, may be reduced based on favorable weather routing forecasts for short voyages as outlined herein. A short voyage is to have a duration of less than 72 hours from departure port to arrival port. In such cases, the transverse acceleration A_T can be reduced by multiplying it with a Short Voyage Reduction Factor f_R as defined below:

$$f_R = H_{s,max} / (2 \cdot \sqrt{B}) + 0.4 \text{ but not to be less than } 0.6, \text{ nor more than } 1.0$$

where

B = molded breadth of the vessel, in m

$H_{s,max}$ = forecast maximum significant wave height* for the entire voyage duration plus an extra 12 hours for contingency, in m

Note:

* If the weather forecast provides swell separately from wind driven waves, the significant wave height may be calculated as:

$$H_{s,max} = \sqrt{(H_{swell}^2 + H_{wind}^2)}$$

where

H_{swell} = Significant wave height due to swell

H_{wind} = Significant wave height due to wind driven waves

Weather-based Short Voyage Reduction Factors may be applied subject to the following requirements:

- i)* The vessel is to have the **CLP-V** notation, and the onboard Computer Lashing Program is to be approved to handle Short Voyage Reduction Factors.
- ii)* The approved Container Securing Manual is to clearly outline the procedure for calculating and applying the Short Voyage Reduction Factor. This is to include a vessel specific reduction factor based on the above equation.
- iii)* The weather forecast report is to be from a national meteorological service, or equivalent, complying with SOLAS Chapter V Regulation 5.

- iv) The Short Voyage Reduction Factor is to be calculated based on weather reports received within 6 hours of departure.
- v) The weather forecast report and printout from the onboard lashing computer are to be retained onboard for each voyage for which a Short Voyage Reduction Factor is applied.
- vi) Weather forecasts are to be monitored throughout the voyage and adverse weather conditions are to be avoided. If adverse weather conditions are encountered the master is to take appropriate measures (speed reduction, heading change, seek refuge).
- vii) For each short voyage, safe refuges should be identified to avoid unanticipated wave environment.
- viii) The Short Voyage Reduction Factor is not to be combined with the Route-Specific Reduction Factors listed in 6/3.7.3.

3.7.5 Accelerations for Route Splitting (2024)

The Route-Specific Reduction Factors for typical trade routes listed in the table of 6/3.7.3 or any other specific trade routes may also be determined with consideration of the Route Splitting approach, in which the entire route is divided into multiple segments. Each segment may be specified by selecting two ports along the route as needed. In such cases, the transverse acceleration, A_T , may be reduced by multiplying it with the Route Splitting Reduction Factor, which can be obtained from the direct calculation according to 6/3.9.

Alternatively, the reduction factors may be determined considering the wave statistics of the combined wave scatter diagram along the segment in comparison with the IACS Rec. No. 34 wave scatter diagram of the North Atlantic for unrestricted services. The exceedance probability of significant wave height is to be applied with a reference service life of 20 years. The Route Splitting Reduction Factor, f_s , of a segment may be determined as follows:

$$f_s = k * H_{S_{SEG}} / H_{S_{NA}}$$

where

- f_s = Route Splitting Reduction Factor, not less than 0.73, but not more than the route-specific reduction factors listed in the table of 6/3.7.3 for typical trade routes or calculated for the entire route of the specific trade routes. In any case, the Route Splitting Reduction Factor is to be not more than 1.0
- $H_{S_{NA}}$ = significant wave height at the reference service life of 20 years from the IACS Rec. No. 34 wave scatter diagram of the North Atlantic for unrestricted service. IACS Rec. No. 34 (Rev.1) is to be used.
- $H_{S_{SEG}}$ = significant wave height at the reference service life of 20 years from the combined wave scatter diagram along the segment of specific route
- k = 1.08

The Route Splitting Reduction Factors may be applied subject to the following requirements:

- i) The vessel is to have the **CLP-V(PARR)** notation, and the calculation of the Route Splitting Reduction Factors for specific routes is to be submitted for review.
- ii) The operational guidance for parametric roll detection and prevention in the form of polar diagrams or other suitable forms provided in the format of hard copy or electronic copy is to be submitted for review.
- iii) Digital onboard operational guidance is to be installed as a stand-alone program or integrated with onboard route planning system. When the digital onboard operational guidance is installed, its functionality of user interface is to be verified to the satisfaction of the attending Surveyor during the initial survey. The user interface should be able to

graphically display the required polar diagram or other suitable formats from the pre-calculated database. The operational guidance for parametric roll detection and prevention provided in the format of hard copy or electronic copy is to be kept on board as a back-up and may be used for the verification of the digital onboard operational guidance.

Commentary:

ABS Guide for the Assessment of Parametric Roll Resonance in the Design of Container Carriers can be used to support the development of the operational guidance for parametric roll detection and prevention.

When an actual operational condition is not available in the pre-calculated database, the closest or interpolated polar diagram may be selected from the database with respect to the draft, GM and wave conditions.

End of Commentary

- iv) Route Splitting Reduction Factor is not to be combined with the Route-Specific Reduction Factors listed in 6/3.7.3 nor the Short-Voyage Reduction Factors in 6/3.7.4.

3.9 Optional Direct Calculation of Accelerations (1 April 2014)

As an alternative to the formulas in this Section, ABS may consider direct calculations of ship motions and accelerations or values obtained from model tests. In such a case, accelerations should be determined with a reference service life of 20 years. As the base case, the IACS Recommendation No. 34 wave scatter diagram for the North Atlantic is to be applied for unrestricted service. In addition to the base case, route-specific criteria may also be considered. For route-specific trades other than the typical trading routes as shown in 6/3.7.3 and Appendix A2, the combined wave scatter diagram or table, to be developed by combining the wave data along each leg of a specific route, is to be submitted for review. Direct calculations or model tests are to be provided as justification if credit for motion reduction from stabilizing systems is requested.

3.11 Mass Distribution and Center of Gravity of Containers

The transverse, longitudinal, and vertical force components due to gravity and ship motions are to be applied at the center of gravity of the container.

For design purposes, the center of gravity of container may be taken as follows:

- Vertical center of gravity at 45% of the height of the container
- Longitudinal center of gravity at the mid-length of the container
- Transverse center of gravity at half the width of the container

Where the center of gravity differs significantly from these values, documentation of the actual center of gravity shall be submitted and included in the Cargo Securing Manual.

3.13 Distribution of Loads Acting on Containers

The transverse, longitudinal, and vertical force components due to gravity and ship motions are to be applied at the center of gravity of the container. The wind force is to be equally distributed over the side of the container. To facilitate the calculations, the forces may be resolved into force components acting at the ends and sides of the container:

FIGURE 5
Application of Forces to Ends and Sides of Container

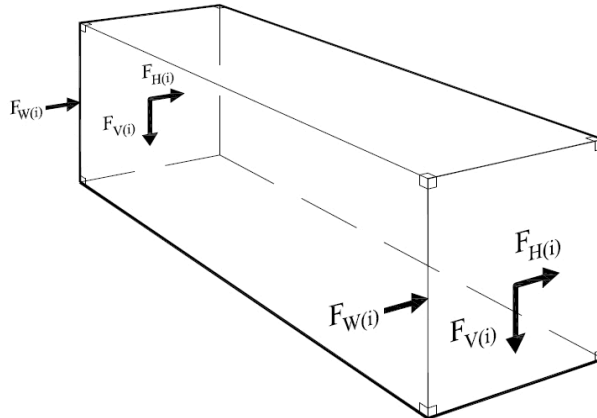

3.13.1 Horizontal Force Component

The horizontal force component acting at the ends of each container is obtained from the following formula:

$$F_{H(i)} = 0.5W_{(i)}A_{T(i)} \quad \text{kN (Ltf)}$$

where

$F_{H(i)}$ = horizontal (across the deck) force per end of container in tier i due to gravity and ship motions.

$W_{(i)}$ = weight of container in tier i , in kN (Ltf)

$A_{T(i)}$ = transverse acceleration at tier i , in g's

Self-racking of the container in way of the end panel is calculated assuming 45% of the horizontal force, $F_{H(i)}$, acts across the top of the container, and 55% of the horizontal force, $F_{H(i)}$, acts across the bottom of the container.

3.13.2 Longitudinal Force Component

The longitudinal force component acting at the sides of each container is obtained from the following formula:

$$F_{L(i)} = 0.5W_{(i)}A_{L(i)} \quad \text{kN(Ltf)}$$

where

$F_{L(i)}$ = longitudinal (parallel to deck) force per side of container in tier i due to gravity and ship motions.

$A_{L(i)}$ = longitudinal acceleration at tier i , in g's

Self-racking of the container in way of the side panel is calculated assuming 45% of the longitudinal force, $F_{L(i)}$, acts across the top of the container, and 55% of the longitudinal force, $F_{L(i)}$, acts across the bottom of the container.

3.13.3 Vertical Force Component

The vertical force component acting at the ends of each container is obtained from the following formula:

$$F_{V(i)} = 0.5W_{(i)}A_{VMAX} \text{ kN(Ltf)} \quad \text{to be applied when evaluating corner post compression}$$

$$F_{V(i)} = 0.5W_{(i)}A_{VMIN} \text{ kN(Ltf)} \quad \text{to be applied when evaluating corner post tension}$$

where

$$F_{V(i)} = \text{vertical (normal-to-deck) force per end of container in tier } i \text{ due to gravity and ship motions.}$$

$$A_{VMAX} = \text{maximum vertical acceleration, in g's}$$

$$A_{VMIN} = \text{minimum vertical acceleration, in g's}$$

3.13.4 Wind Load (1 April 2021)

The wind load acting at the ends of each container is obtained from the following formula:

$$F_{W(i)} = 0.5P_W L_{C(i)} H_{C(i)} \text{ kN(Ltf)}$$

where

$$F_{W(i)} = \text{wind force per end of container in tier } i$$

$$P_W = 1.08\cos^2\theta \text{ kN/m}^2 \text{ (} 0.0101\cos^2\theta \text{ Ltf/ft}^2 \text{), as defined in 6/3.3.1}$$

$$L_{C(i)} = \text{length of container in tier } i, \text{ in m (ft), as defined in 3/3 TABLE 1A}$$

$$H_{C(i)} = \text{height of container in tier } i, \text{ in m (ft), as defined in 3/3 TABLE 1A}$$

Self-racking of the container in way of the end panel is calculated assuming 50% of wind force, $F_{W(i)}$, acts across the top of the container, and 50% of the wind force, $F_{W(i)}$, acts across the bottom of the container.

5 Analysis Procedure for Container Securing System (1 March 2024)

A linear analysis procedure is described in 6/5.3 through 6/5.11. This linear procedure is to be used for container stacks secured by internal lashing systems or container stacks without lashings.

Container stacks secured by **vertical lashings** or an external lashing system are to account for non-linearities. The procedure requires this linear analysis be adjusted in accordance with the procedure described in 6/5.13.

The "ABS C-Lash[®]" software program is based on the analysis procedure presented in this subsection and can be used to analyze container stacks secured by external, internal and no lashing systems.

While the procedure is presented with regard to the door and closed ends of a typical container stack for Condition A (defined in 6/3.7.1), it can also be used for Condition B (defined in 6/3.7.2).

The analysis procedure is to be applied to Condition A and Condition B along with the following lashing platform and twistlock conditions:

- Condition A: Lashing platform is assumed rigid. For external **and vertical** lashings, the container corner separations (also referred to as twistlock gaps hereafter) due to twistlock vertical clearance are to be considered at only two locations **on the tension side of the container stack**: at the highest lashing point twistlock location and the twistlock location immediately below. A minimum of 12 mm is to be used as the twistlock vertical clearance for manual and semi-automatic twistlocks. A minimum of 20 mm is to be used as the twistlock vertical clearance for fully automatic twistlocks. If manufacturers claim lesser values of twistlock vertical clearance, twistlock test results are to be provided to ABS for special consideration. Twistlock vertical clearances are not to be considered for internal lashings. Twistlock transverse clearances are not to be considered for **external, vertical, and** internal lashings.
- Condition B: Lashing platform flexibility is to be properly considered for lashing platforms of 4 tiers or higher for interior stacks or 5 tiers or higher for wind exposed stacks, and twistlock clearance in vertical and longitudinal directions is not to be considered.

5.1 General (1 September 2022)

For each container, the following loads are to be evaluated:

- Racking of the container end wall
- Corner post compression (into the top of the corner post)
- Vertical tension (acting at the top of the corner post and on the adjacent twistlock)
- Vertical tension (acting at the bottom of the corner post and on the adjacent twistlock)

For each lashing assembly, the following loads are to be evaluated:

- Tension in the lashing assembly
- Force exerted by the lashing assembly on the container corner fitting

5.3 Container End Wall Racking (1 September 2022)

The procedure described in 6/5.3 is applicable to external and internal lashing arrangements.

The transverse force acting across the top of each end of the container at tier i , when no transverse lashing restraint is considered, is obtained with the following formula:

$$Q_{(i)} = r_T F_{H(i)} + r_W F_{W(i)} + \sum_{j=i+1}^n (F_{H(j)} + F_{W(j)}) \text{ kN (Ltf)}$$

where

i = container tier being evaluated

n = number of tiers

r_T = portion of the horizontal force, $F_{H(i)}$ acting on container i that is considered to contribute to the racking force on container i (to be taken as 0.45 as defined in 6/3.13.1).

r_W = portion of the wind force, $F_{W(i)}$, acting on container i that is considered to contribute to the racking force on container i (to be taken as 0.5 as defined in 6/3.13.4).

See Section 6, Figure 4 for the racking force distribution of a 3-tier high container stack without lashing restraint.

FIGURE 6
Racking Force without Lashing Restraint (3-tier High Stack)

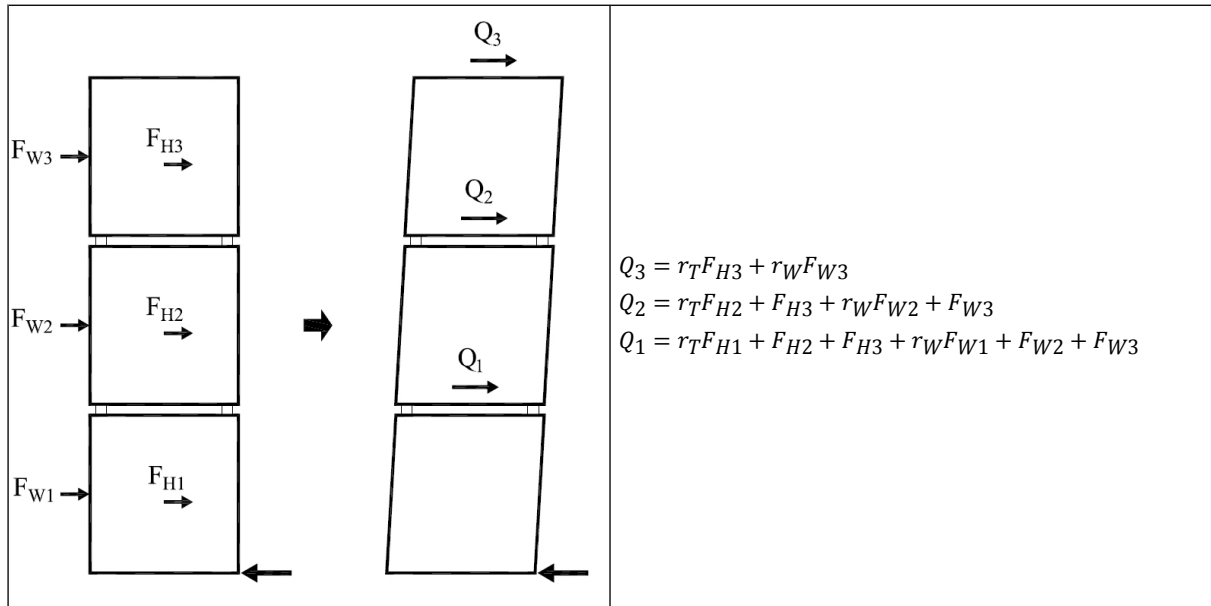

For stacks without lashing assemblies or other transverse restraints, or where all lashing assemblies are attached to the containers at or below the bottom of container *i*, the racking force on container *i* is obtained with the following formula:

$$R_{(i)} = Q_{(i)} \text{ kN (Ltf)}$$

where

$$R_{(i)} = \text{racking force acting on container } i$$

When lashing assemblies or other transverse restraints are secured to the corner fittings at the top of the container in tier *i* or to containers above tier *i*, the racking force is reduced by the horizontal component of these lashing forces.

$$R_{(i)} = Q_{(i)} - \sum_{j=k}^m F_{\ell H(j)} \text{ kN (Ltf)}$$

where

$$F_{\ell H(j)} = \text{horizontal component of lashing tension from lashing assembly } j, \text{ in kN (Ltf)}$$

$$k = \text{first lashing assembly secured at or above the corner fittings at the top of the tier } i \text{ container}$$

$$m = \text{uppermost lashing assembly secured at or above the corner fittings at the top of the tier } i \text{ container}$$

See Section 6, Figure 5 for an illustration of racking force distribution of a 3-tier high container stack with lashing restraint.

FIGURE 7
Racking Force with Lashing Restraint (3-tier High Double Lashed Stack)

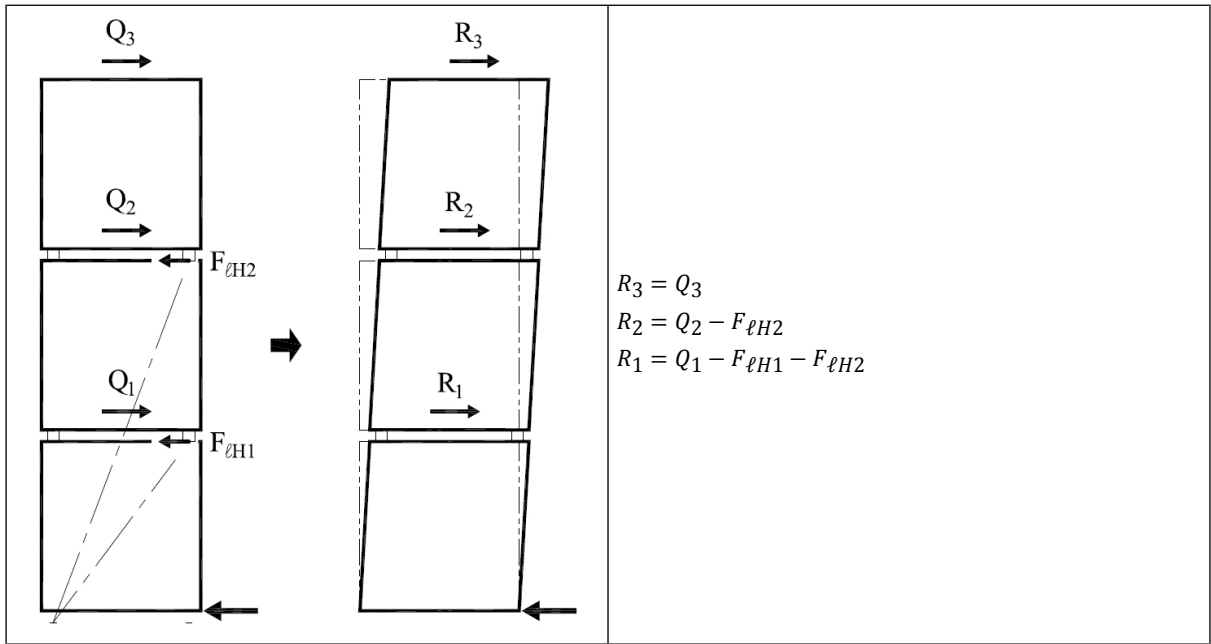

The racking forces are to be evaluated for each container in the stack. The racking force, $R(i)$, acting on each container is to be less than or equal to the *End Wall Racking* design load for that container.

5.5 Lashing Tension (1 September 2022)

The procedure described in 6/5.5 is applicable to external and internal lashing arrangements.

5.5.1 Lashing Geometry

FIGURE 8
Lashing Angle and Lashing Length

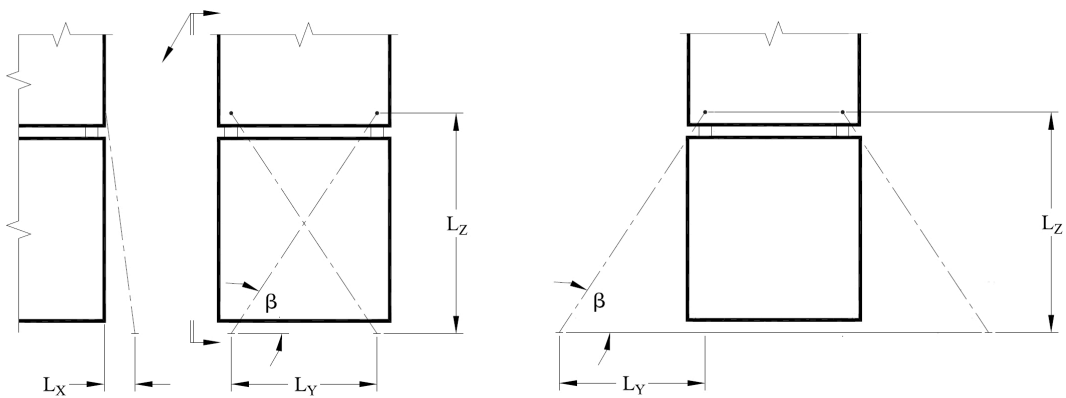

5.5.1(a) The lashing length is determined based on the actual geometry of the lashing assembly, see Section 6, Figure 6.

$$L_\ell = \sqrt{L_z^2 + L_y^2 + L_x^2} \text{ mm (in.)}$$

where

L_ℓ = length of lashing assembly, in mm (in.)

L_Z = vertical extent of lashing assembly, in mm (in.), to be taken as the vertical distance from the attachment point on the hatch cover, deck, or lashing bridge to the corner fitting of the container.

L_Y = transverse (horizontal) extent of lashing assembly, in mm (in.), to be taken as the transverse distance from the attachment point on the hatch cover, deck, or lashing bridge to the corner fitting of the container.

L_X = longitudinal extent of lashing assembly, in mm (in.), to be taken as the longitudinal distance from the attachment point on the hatch cover, deck, or lashing bridge to the face of the container end panel.

β = lashing angle, in degrees

$$= \cos^{-1}(L_Y/L_\ell)$$

5.5.1(b) The horizontal component of the lashing spring constant is obtained from the following formula:

$$K_{\ell H} = K_\ell \left(\frac{L_Y}{L_\ell} \right)^2 \quad \text{kN/mm (Ltf/in)}$$

where

K_ℓ = lashing spring constant, as defined in 4/3.5.2, in kN/mm (Ltf/in)

5.5.1(c) The horizontal and vertical components of the lashing force are obtained from the following formulas:

$$F_{\ell H} = T_\ell \frac{L_Y}{L_\ell} \quad \text{kN (Ltf)}$$

$$F_{\ell V} = T_\ell \frac{L_Z}{L_\ell} \quad \text{kN (Ltf)}$$

where

T_ℓ = tensile force in the lashing assembly, in kN (Ltf)

5.5.2 Calculation of Lashing Tension

5.5.2(a) The horizontal displacement at the top of container tier may be expressed as a function of the racking force and container spring constant:

$$\Delta_{(i)} = \frac{R_{(i)}}{K_{C(i)}} + \Delta_{(i-1)} \quad \text{or} \quad \Delta_{(i)} = \sum_{j=1}^i \frac{R_{(j)}}{K_{C(j)}} \quad \text{mm (in.)}$$

where

$\Delta_{(i)}$ = horizontal displacement at the top of tier i , in mm (in.)

$\Delta_{(i-1)}$ = horizontal displacement at the top of the tier immediately below tier i , in mm (in.)

$R_{(i)}$ = transverse racking force acting across the top of each end wall, in kN (Ltf), as defined in 6/5.3

$K_{C(i)}$ = racking spring constant of tier i container, in kN/mm (Ltf/in)

See Section 6, Figure 7 for an illustration of the horizontal displacements at the tops of containers of a 3-tier high container stack.

FIGURE 9
Horizontal Displacement (3-tier High Double Lashed Stack)

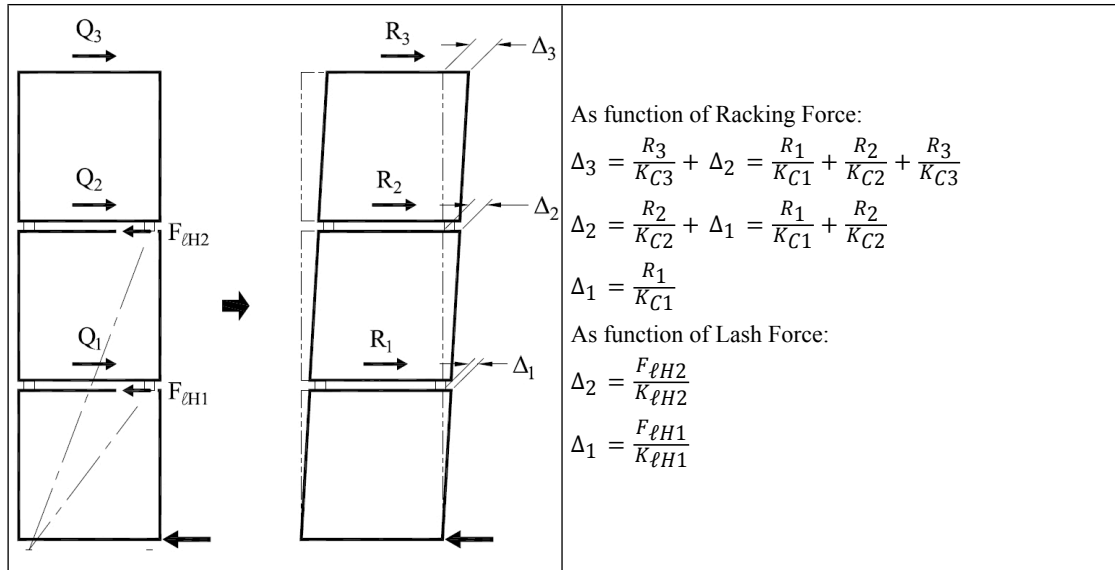

5.5.2(b) The horizontal displacement at the top of container tier i may also be expressed as a function of the horizontal component of lashing force and spring constant:

$$\Delta_{(i)} = \frac{F_{\ell H(j)}}{K_{\ell H(j)}} \quad \text{mm (in.)}$$

where

$F_{\ell H(j)}$ = horizontal force component of lashing assembly j , in kN (Ltf)

$K_{\ell H(j)}$ = horizontal component of the spring constant of lashing assembly j , in kN/mm (Ltf/in)

5.5.2(c) The horizontal component of the spring constant of the lashing is obtained with the following equation:

$$K_{\ell H(j)} = K_{\ell(j)} \cos^2 \beta_{(j)} \quad \text{kN/mm (Ltf/in)}$$

where

$K_{\ell(j)}$ = spring constant of the lashing assembly j , as defined in 4/3.5.2

$\beta_{(j)}$ = lashing angle of the lashing assembly j , in degrees

5.5.2(d) The horizontal displacement induced by the racking force as defined in 6/5.5.2(a) must equal the horizontal displacement relative to the elongation of the lashing assembly as defined in

6/5.5.2(b). The load into each lashing assembly can be determined by combining these equations and solving for the horizontal lashing force at each lashing assembly.

The tension in the lashing assembly is obtained with the following equation:

$$T_{\ell(j)} = \frac{F_{\ell H(j)}}{\cos\beta(j)} \quad \text{kN (Ltf)}$$

The calculated lashing tension for each lashing assembly is to be less than or equal to the design load of the lashing assembly. As described in Subsection 4/7, the design load is determined by dividing the minimum breaking strength of the lashing assembly by the safety factor given in Section 4, Table 3.

For the purposes of calculating the racking, compression, and tension loads acting on the containers, the horizontal component of lashing tension may be assumed to be acting along the top of the container.

5.5.3 Lashing Tension Equation for Single Lashing to Deck

FIGURE 10
Lashing Elongation at First Tier Container

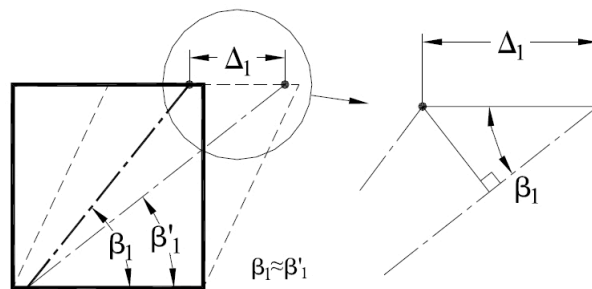

The lashing equation for a stack secured with a single cross lashing system to the deck is derived as shown below, See an illustration in Section 6, Figure 8.

The horizontal displacements of the 1st tier container may be expressed as a function of the racking force and container spring constant.

$$\Delta_1 = \frac{R_1}{K_{C1}} = \frac{Q_1 - F_{\ell H1}}{K_{C1}} \quad \text{mm (in.)}$$

where

Δ_1 = horizontal displacement at the top of the 1st tier, in mm (in.)

R_1 = end wall racking force across the top of the 1st tier, as defined in 6/5.3, in kN (Ltf)

Q_1 = end wall racking force across the top of the 1st tier when the contribution from lashings is not considered, as defined in 6/5.3, in kN (Ltf)

K_{C1} = racking spring constant of the 1st tier container, in kN/mm (Ltf/in)

The horizontal displacements of the 1st tier container may be expressed as a function of the horizontal component of the lashing force and the horizontal component of the lashing spring constant.

$$\Delta_1 = \frac{F_{\ell H1}}{K_{\ell H1}} \quad \text{mm (in.)}$$

where

$F_{\ell H1}$ = horizontal force component of the lashing assembly, in kN (Ltf)

$K_{\ell H1}$ = horizontal component of the spring constant of lashing assembly, in kN/mm (Ltf/in)

The horizontal displacement induced by the racking force equals the displacement relative to the elongation of the lashing assembly.

$$\frac{F_{\ell H1}}{K_{\ell H1}} = \frac{Q_1 - F_{\ell H1}}{K_{C1}}$$

$$F_{\ell H1} = Q_1 \left(\frac{K_{\ell H1}}{K_{C1} + K_{\ell H1}} \right)$$

The tension in the lashing assembly is obtained as follows:

$$T_{\ell 1} = \frac{F_{\ell H1}}{\cos \beta_1} = \frac{Q_1}{\cos \beta_1} \left(\frac{K_{\ell H1}}{K_{C1} + K_{\ell H1}} \right) \quad \text{kN/mm (Ltf/in)}$$

5.5.4 Lashing Tension Equations

Lashing tension should be evaluated based on these principles for the actual arrangement under consideration. Three typical equations are presented in Section 6, Table 1:

- Single Cross Lashing to Deck
- Double Cross Lashing to Deck
- Single Cross Lashing to Lashing Bridge

TABLE 1
Lashing Equations for Typical Arrangements

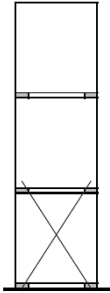
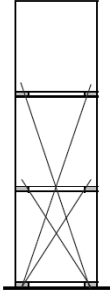
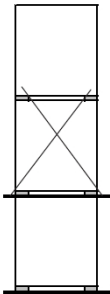
Type	Lashing Tension Equation
<p>Single Lashing to Deck</p> 	<p>Lashing from deck to top of 1st or bottom of 2nd tier</p> $F_{\ell H1} = Q_1 \left(\frac{K_{\ell H1}}{K_{C1} + K_{\ell H1}} \right)$ $T_{\ell 1} = \frac{F_{\ell H1}}{\cos \beta_1}$
<p>Double Lashing to Deck</p> 	<p>Lashing from deck to top of 1st or bottom of 2nd tier</p> $F_{\ell H1} = K_{\ell H1} \left[\frac{(K_{C2} + K_{\ell H2})Q_1 - K_{\ell H2}Q_2}{(K_{C1} + K_{\ell H1})(K_{C2} + K_{\ell H2}) + K_{C2}K_{\ell H2}} \right]$ $T_{\ell 1} = \frac{F_{\ell H1}}{\cos \beta_1}$ <p>Lashing from deck to top of 2nd or bottom of 3rd tier</p> $F_{\ell H2} = K_{\ell H2} \frac{K_{C2}Q_1 + (K_{C1} + K_{\ell H1})Q_2}{(K_{C1} + K_{\ell H1})(K_{C2} + K_{\ell H2}) + K_{C2}K_{\ell H2}}$ $T_{\ell 2} = \frac{F_{\ell H2}}{\cos \beta_2}$
<p>Single Lashing to Single Tier Lashing Bridge</p> 	<p>Lashing from the lashing bridge to the top of 2nd or bottom of 3rd tier</p> $F_{\ell H2} = K_{\ell H2} \left[\frac{K_{C2}Q_1 + K_{C1}Q_2}{K_{C1}(K_{C2} + K_{\ell H2}) + K_{C2}K_{\ell H2}} \right]$ $T_{\ell 2} = \frac{F_{\ell H2}}{\cos \beta_2}$

5.5.5 Analysis of Paired Lashings

A paired lashing system may be analyzed by combining the horizontal components of the spring constants of the two lashings. If the lower and upper lashings of the two are designated by *A* and *B*, respectively, then:

$K_{\ell H(i)A} = K_{\ell(i)A} \cos^2 \beta_{(i)A}$ horizontal lashing spring stiffness for the lower lashing assembly

$K_{\ell H(i)B} = K_{\ell(i)B} \cos^2 \beta_{(i)B}$ horizontal lashing spring stiffness for the upper lashing assembly

$K_{\ell H(i)} = K_{\ell H(i)A} + K_{\ell H(i)B}$ combined horizontal lashing spring stiffness

By applying the combined spring constant for $K_{\ell H(j)}$ in the equations in Section 6, Table 1, $F_{\ell H(i)}$ is the transverse force exerted by the combination of the two lashing assemblies.

The lashing tension of the individual lashing assemblies can be resolved from $F_{\ell H(j)}$:

$$\begin{aligned} F_{\ell H(i)A} &= F_{\ell H(i)} \frac{K_{\ell H(i)A}}{K_{\ell H(i)}} & T_{\ell(i)A} &= \frac{F_{\ell H(i)A}}{\cos \beta_{(i)A}} & F_{\ell V(i)A} &= T_{\ell(i)A} \frac{L_{Z(i)A}}{L_{\ell(i)A}} \\ F_{\ell H(i)B} &= F_{\ell H(i)} \frac{K_{\ell H(i)B}}{K_{\ell H(i)}} & T_{\ell(i)B} &= \frac{F_{\ell H(i)B}}{\cos \beta_{(i)B}} & F_{\ell V(i)B} &= T_{\ell(i)B} \frac{L_{Z(i)B}}{L_{\ell(i)B}} \end{aligned}$$

5.7 Lashing Force on Container Corner Fitting (1 September 2022)

The procedure described in 6/5.7 is applicable to external and internal lashing arrangements.

The lashing force on the corner fitting should be evaluated for each lashing assembly. The calculated lashing tension, $T_{\ell(j)}$, must be less than or equal to the design load for the corner fitting. The design load for the corner fitting, $F_{CF(k)}$, is determined as a function of the lashing angle, β :

$$F_{CF(k)} = \frac{C_{FH}}{\cos \beta_{(j)}} \quad \text{KN (Ltf)}$$

$F_{CF(k)}$ is not to be taken greater than C_{FV}

where

- C_{FH} = design lashing force on corner fitting, horizontal, as defined in Subsection 3/5, in kN (Ltf)
- C_{FV} = design lashing force on corner fitting, vertical, as defined in Subsection 3/5, in kN (Ltf)
- $\beta_{(j)}$ = lashing angle for lashing assembly j
- k = container tier to which lashing assembly j is attached

5.9 Corner Post Compression (1 September 2022)

The procedure described in 6/5.9 is for internal lashing arrangements. The same principle can be applied to the calculations of corner post compression and twistlock forces for external lashing arrangements. A general rule is that, the connection of a corner post to a corner fitting is considered as the calculation point when deciding which forces are to be included in the calculations of corner post compression.

The forces that are considered when determining the compressive force acting on the bottom and top of the 1st tier container are shown in Section 6, Figure 9. Compressive forces are calculated by summing moments about point z_A .

FIGURE 11
Corner Post Compression

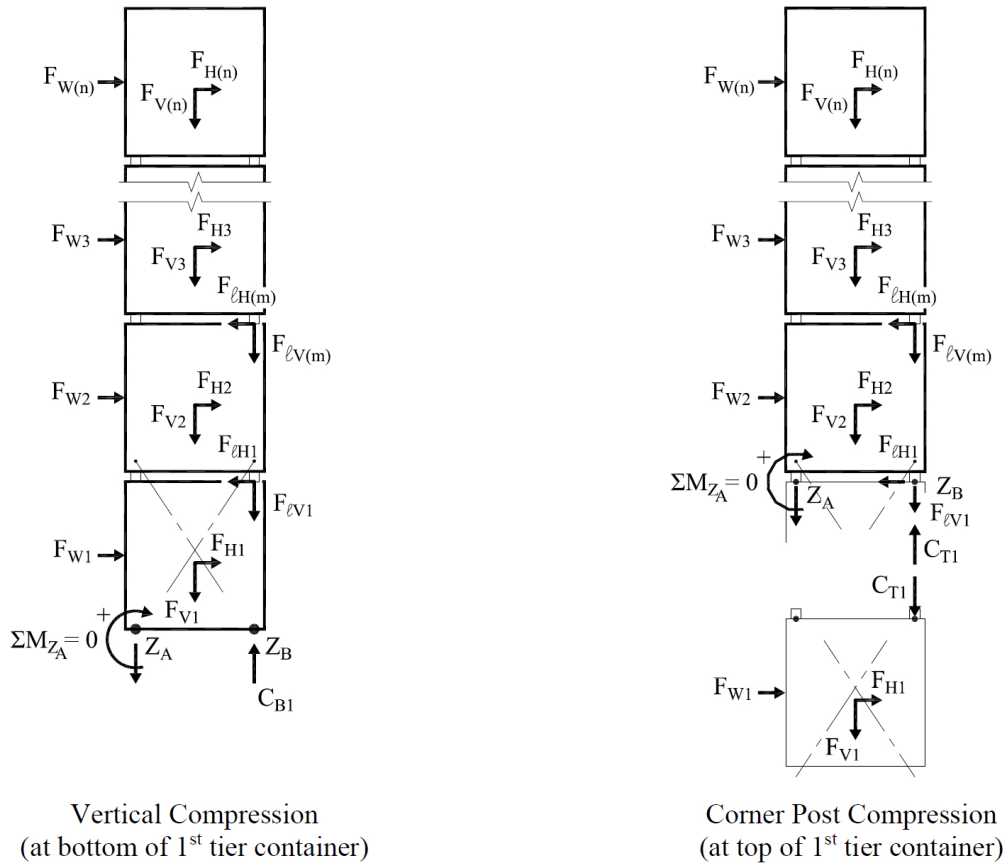

The compressive load at the base of each container is obtained with the following formula:

$$C_{B(i)} = \frac{\sum_{j=i}^n i^h c(j) F_{H(j)} + \sum_{j=i}^n i^b c F_{V(j)} + \sum_{j=i}^n i^h w(j) F_{W(j)} - \sum_{j=i}^m k^h \ell(j) F_{\ell H(j)} + \sum_{j=i}^m k^b \ell(j) F_{\ell V(j)}}{b_{CF}}$$

The compressive load at the top of each container is obtained with the following formula:

$$C_{T(i)} = \frac{\sum_{j=i+1}^n i+1^h c(j) F_{H(j)} + \sum_{j=i+1}^n i+1^b c F_{V(j)} + \sum_{j=i+1}^n i+1^h w(j) F_{W(j)} - \sum_{j=i+1}^m k^h \ell(j) F_{\ell H(j)} + \sum_{j=i+1}^m k^b \ell(j) F_{\ell V(j)}}{b_{CF}}$$

Twistlock force can be calculated using the following formulas:

$$\begin{aligned} C_{B(i)}^{TL} &= C_{B(i)} + F_{\ell V(i-1)} \text{ if the lashing assembly at tier } i-1 \text{ is above the twistlock} \\ &= C_{B(i)} + F_{\ell V(i-1)B} \text{ if a paired lashing is installed at tier } i-1 \\ &= C_{B(i)} \text{ otherwise} \\ C_{T(i)}^{TL} &= C_{T(i)} - F_{\ell V(i)} \text{ if the lashing assembly at tier } i \text{ is below the twistlock} \\ &= C_{T(i)} - F_{\ell V(i)A} \text{ if a paired lashing is installed at tier } i \\ &= C_{T(i)} \text{ otherwise} \end{aligned}$$

where

$C_{B(i)}$	=	corner post compression into the bottom of container at tier i , in kN (Ltf)
$C_{T(i)}$	=	corner post compression into the top of container at tier i , in kN (Ltf)
$C_{B(i)}^{TL}$	=	twistlock force (+ compression) at the bottom of container at tier i , in kN (Ltf)
$C_{T(i)}^{TL}$	=	twistlock force (+ compression) at the top of container at tier i , in kN (Ltf)
i	=	tier of the container being evaluated for corner post compression
n	=	number of containers in the stack
k	=	first lashing assembly secured at or above the corner fittings at the top of the tier i container
m	=	uppermost lashing assembly secured at or above the corner fittings at the top of the tier i container
$F_{H(j)}$	=	horizontal (across-the-deck) force per end of container j , due to gravity and ship motions, in kN (Ltf)
$F_{V(j)}$	=	vertical (normal-to-deck) force per end of container j , due to gravity and ship motions, in kN (Ltf)
$F_{W(j)}$	=	force per end of container due to wind load acting on the side of the container j , in kN (Ltf)
$F_{\ell H(j)}$	=	horizontal force component of lashing assembly j , in kN (Ltf)
$F_{\ell V(j)}$	=	vertical force component of lashing assembly j , in kN (Ltf)

Point z_A is taken at the top or bottom of the container being evaluated. When evaluating loads imposed on the 1st tier container, the distances from point z_A to the centers of forces acting on the containers are as shown in Section 6, Figure 10.

FIGURE 12
Distances to Forces Acting on Containers

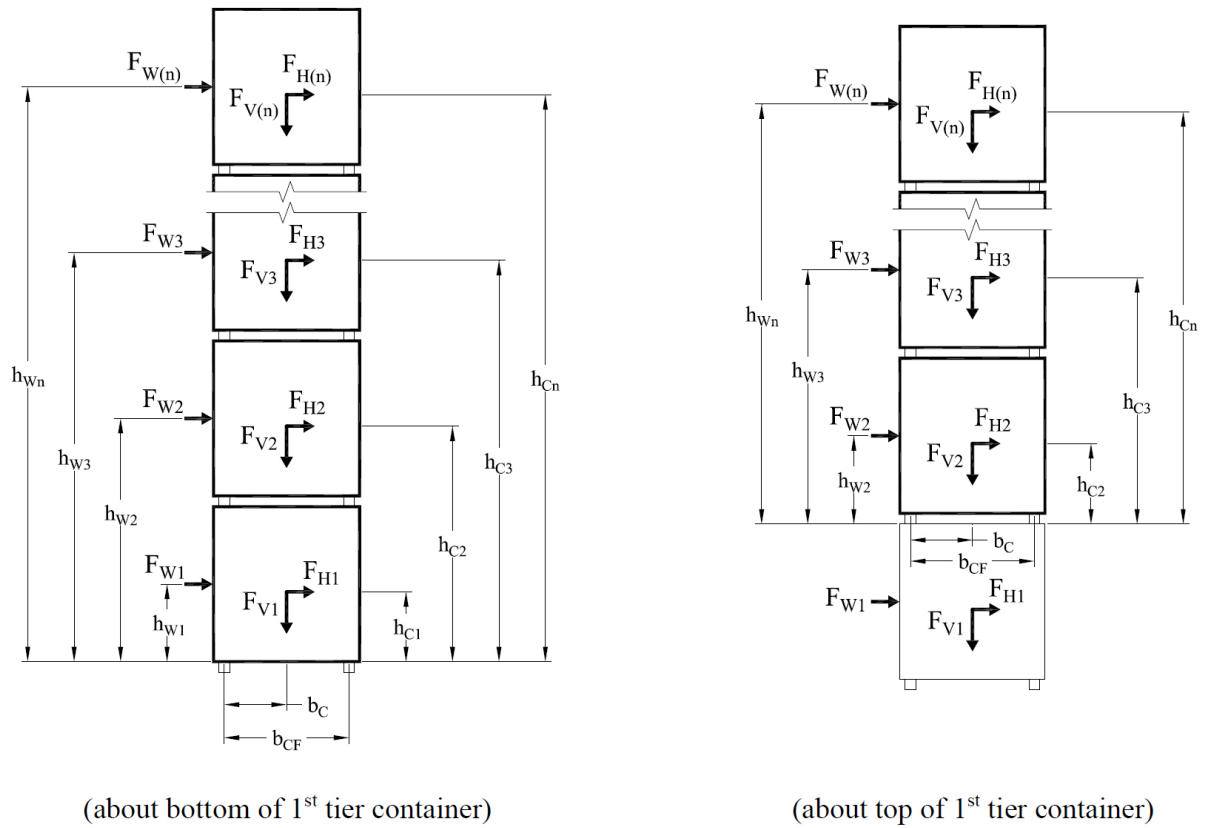

- $h_{C(j)}$ = vertical distances measured from the location being analyzed (either the top or bottom of the container) to the center of gravity of container j , in m (ft)
- $h_{W(j)}$ = vertical distances measured from the location being analyzed (either the top or bottom of the container) to the center of wind pressure on container j , to be taken to the mid-height of the container j , in m (ft)
- b_{CF} = transverse distance between centers of the container corner fittings, to be taken as 2.259 m (7.411 ft)
- b_C = transverse distances measured from z_A to the center of gravity of the container, to be taken to the mid-width of the container, in m (ft)
- $h_{\ell(j)}$ = vertical distances, in m (ft), measured from the location being analyzed (either the top or bottom of the container) to the attachment point of lashing assembly j . Where the lashing assembly is attached to the upper container corner fittings, $h_{\ell(j)}$ may be taken to the top of the container to which it is attached. Where the lashing assembly is attached to the lower container corner fittings, $h_{\ell(j)}$ may be taken to the top of the container immediately below the container to which it is attached.
- $b_{\ell(j)}$ = transverse distances measured from z_A to the attachment point of lashing assembly j , in m (ft)

Corner post compression is to be evaluated at the top and bottom of each container in the stack. When all containers have equal strength properties, it is generally sufficient to evaluate compression for the 1st tier container only.

The compressive force, $C_{B(i)}$, acting at the base of each container is to be less than or equal to the *Vertical Compression on Bottom Corner Fitting* design load for that container. The compressive force, $C_{T(i)}$, acting at the top of each container is to be less than or equal to the *Corner Post Compression* design load for that container.

5.11 Corner Post Tension (1 September 2022)

The calculation procedure described in 6/5.11 is for internal lashing arrangements. The same principle can be applied to the calculations of corner post tension and twistlock forces for external lashing arrangements. A general rule is that, the connection of a corner post to a corner fitting is considered as the calculation point when deciding which forces are to be included in the calculations of corner post tension.

The forces that are considered when determining the tension loads acting on the bottom and top of the 1st tier container are shown in Section 6, Figure 11. The tension loads are calculated by summing moments about point Z_B .

**FIGURE 13
Corner Post Tension**

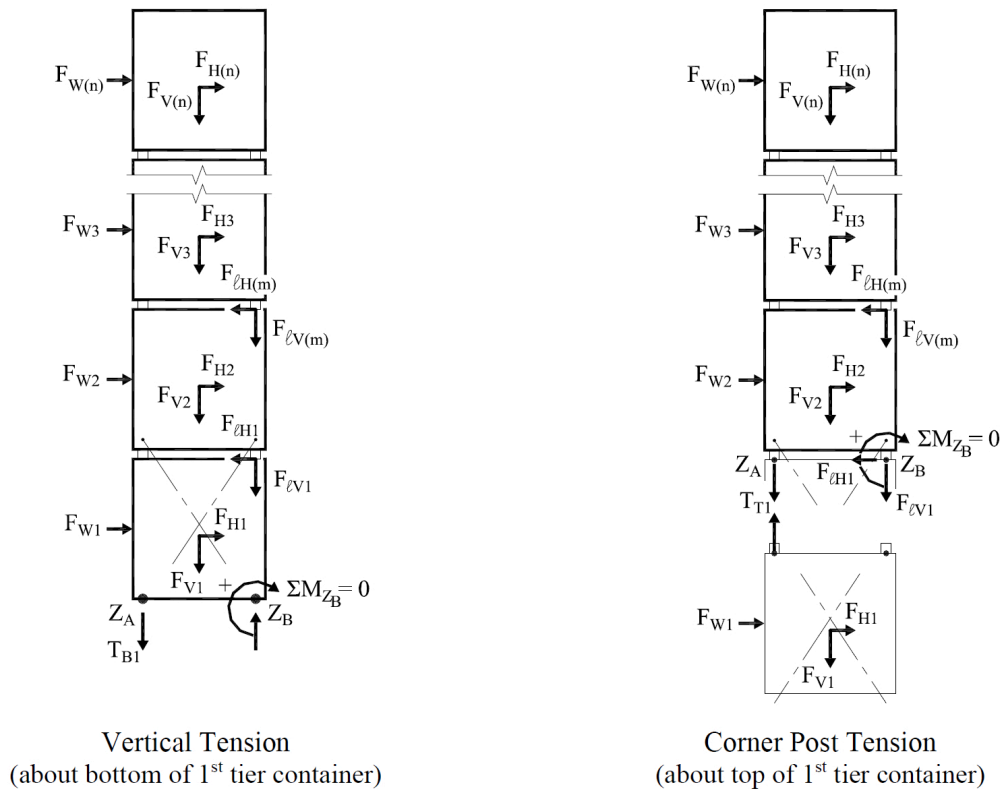

The tensile load at the base of each container is obtained with the following formula.

$$T_{B(i)} = \frac{\sum_{j=1}^n i h_{C(j)} F_{H(j)} - \sum_{j=1}^n i b_{CF} F_{V(j)} + \sum_{j=1}^n i h_{W(j)} F_{W(j)} - \sum_{j=1}^m k h_{\ell(j)} F_{\ell H(j)} - \sum_{j=1}^m k b_{\ell(j)} F_{\ell V(j)}}{b_{CF}}$$

The tensile load at the top of each container is obtained with the following formula.

$$T_{T(i)} = \frac{\sum_{j=1}^n i + 1 h_{C(j)} F_{H(j)} - \sum_{j=1}^n i + 1 b_{CF} F_{V(j)} + \sum_{j=1}^n i + 1 h_{W(j)} F_{W(j)} - \sum_{j=1}^m k h_{\ell(j)} F_{\ell H(j)} - \sum_{j=1}^m k b_{\ell(j)} F_{\ell V(j)}}{b_{CF}}$$

Twistlock tension can be calculated using the following formulas:

$$T_{B(i)}^{TL} = T_{B(i)}$$

$$T_{T(i)}^{TL} = T_{T(i)}$$

where

$T_{B(i)}$ = force (+ tension) acting on the bottom of the container at tier i , in kN (Ltf)

$T_{T(i)}$ = force (+ tension) acting on the top of the container at tier i , in kN (Ltf)

$T_{B(i)}^{TL}$ = twistlock force (+ tension) at the bottom of the container at tier i , in kN (Ltf)

$T_{T(i)}^{TL}$ = twistlock force (+ tension) at the top of the container at tier i , in kN (Ltf)

i = tier of the container being evaluated for corner post tension

n = number of containers in stack

k = first lashing assembly secured at or above the corner fittings at the top of the tier i container

m = uppermost lashing assembly secured at or above the corner fittings at the top of the tier i container

The force components $F_{H(j)}$, $F_{V(j)}$, $F_{W(j)}$, $F_{\ell H(j)}$ and $F_{\ell V(j)}$ are as defined in 6/5.9. The distances to the centers of forces $h_{C(j)}$, $h_{W(j)}$, b_{CF} , b_C , $h_{\ell(j)}$ and $b_{\ell(j)}$ are similar to those shown in Section 6, Figure 10 and described in 6/5.9, except that the distances are measured from point z_B .

Corner post tension is to be evaluated at the top and bottom of each container in the stack. The tension force, $T_{B(i)}$, acting at the base of each container is to be less than or equal to the *Vertical Tension on Bottom Corner Fitting* design load for that container. The tension force, $T_{T(i)}$, acting at the top of each container is to be less than or equal to the *Vertical Tension on Top Corner Fitting* design load for that container.

5.13 Adjustments to Linear Results for External and Vertical Lashings (1 March 2024)

The procedure and its associated equations described in 6/5.1 through 6/5.11 is a linear analysis approach for container securing systems based on a few assumptions. Nonlinearities introduced by twistlock clearance and lashing assemblies are to be taken into account in the analysis of Condition A for container securing systems that use external or vertical lashings. The loads on container securing systems calculated using the linear approach are to be adjusted according to the procedure described below before they are evaluated against their design limits. Alternative analysis procedures based on sound engineering principles and taking into account the nonlinearities of container securing systems can be considered.

For external and vertical lashings, the container corner separation due to twistlock vertical clearance is to be considered at only two locations **on the tension side of the container stack**: at the highest lashing point twistlock location (location m) and the twistlock location immediately below (location $m-1$). It is assumed that the top lashing assembly is linked at the bottom of a container. The corner separation status and magnitudes at the two twistlock locations depend on the loads in the two twistlocks, and will affect back the overall load distributions in the container securing system. Therefore, an iterative (nonlinear) analysis process is needed to correctly capture this effect. The flowchart shown in Section 6, Figure 12 provides the general steps of the process, where $T_{B(m)}^L$ (+ tension) is the twistlock force at location m calculated through the linear analysis, and $T_{B(m-1)}^{NL1}$ (+ tension) is the adjusted twistlock force at location $m-1$, taking into account the corner separation at location m .

FIGURE 14
General Steps of Adjustment (1 March 2024)

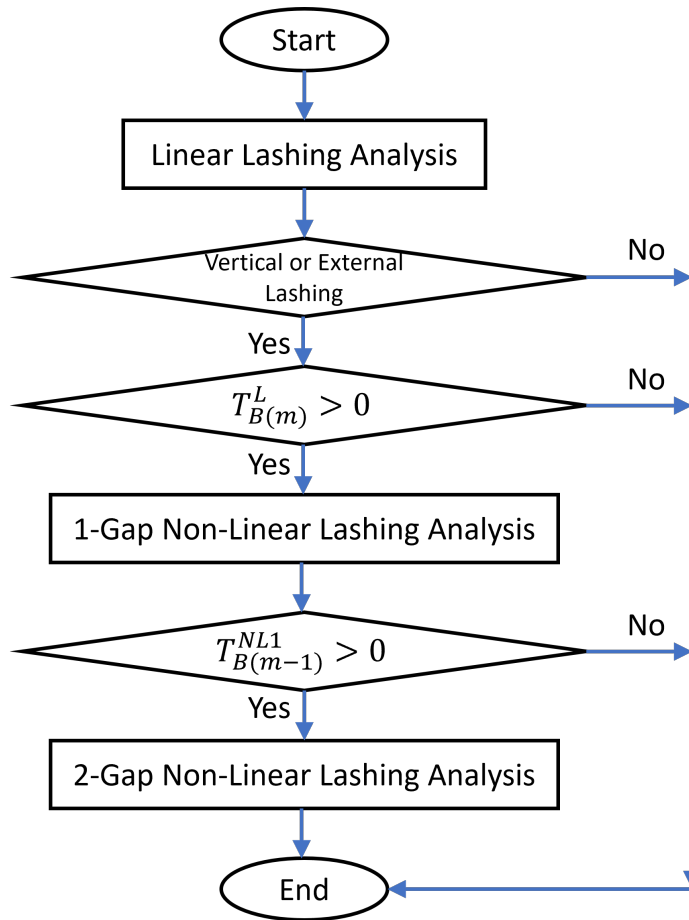

Note:

1-Gap Non-Linear Lashing Analysis is a procedure that only takes into account the twistlock clearance at the first twistlock location immediately below the top lashing rod on the tension side of the container stack (see Section 6, Figure 13(a)).

2-Gap Non-Linear Lashing analysis is a procedure that takes into account twistlock clearances at the first and second twistlock locations below the top lashing rod on the tension side of the container stack (see Section 6, Figure 13(b)).

FIGURE 15
Non-Linear Lashing Analysis

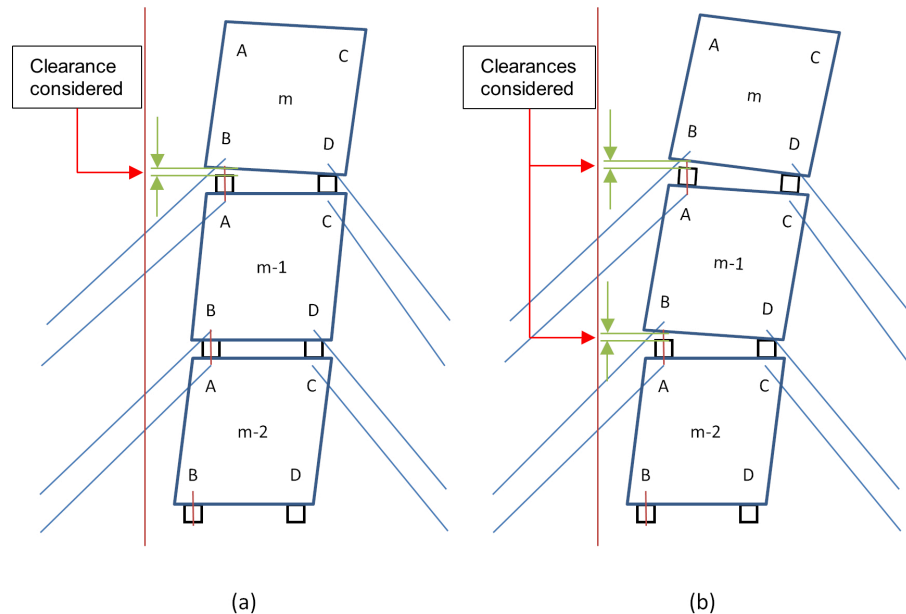

7 Design Application

7.1 General

For securing systems with adjustable and flexible securing components, such as a lashing assembly, pretensioning is to be kept to a minimum. Where pretensioning is an integral part of a securing system, it is to be specially considered.

For each stack or block of containers, the wind loads and forces acting on the containers are to be determined in accordance with 6/3.

7.3 Stacks Secured with Twistlocks Only

For a stack of containers that is secured using only twistlocks between containers and the base, the loads on the containers in each tier are to be analyzed for end wall racking, corner post compression and corner post tension following the methodology described in 6/5.5, 6/5.9, and 6/5.11.

7.5 Stacks Secured with Cross Lashing or Side Lashing Systems

Independent stacks of containers secured with a flexible cross lashing or side lashing system are to be analyzed using the methodology described in 6/5.

7.7 Stacks Secured with Vertical Lashings

The restraining force of a vertical lashing may be analyzed in a similar manner to the procedure presented in 6/5.5 and 6/5.7, except that this force will act in conjunction with the container corner post tension loads that restrain vertical uplift. Sharing of this load is dependent upon the stiffness of each component but is also a function of the tolerance between the lock fittings (twistlocks) and the contact surface of the container corner castings. All lock fittings are designed and manufactured with a small tolerance or gap to the mating surfaces of the container corner castings, and therefore a small amount of sliding or uplift occurs until contact between bearing surfaces occurs and load is transferred. A vertical lashing that is made taut when installed supports the entire vertical uplift load initially and then stretches to a distance equivalent to the sum of the tolerances for all of the lock fittings. For example, for a vertical lashing to the bottom corner casting of the third tier, the stretch in the lashing assembly would have to exceed the

tolerances for three lock fittings before these fittings and the container corner posts would begin to provide vertical restraint. However, because the container corner posts are significantly stiffer than the vertical lashing, most of the load above that threshold would be borne by the container.

7.9 Container Stacks within Cell Guides

The wind loads and forces resulting from the ships motions are to be applied to the containers in the stack and thence to the cell guides and support structure assuming contact in way of the upper and lower container corner castings. Since the lateral loads and therefore also tipping are restrained by the cell guides, the primary container load to check is corner post compression. Also, the corner post compression load at the bottom of the first tier container must not exceed the strength of the support structure below.

The lateral loads are to be applied to the cell guides in a manner that represents the most severe arrangement of different height containers anticipated for the intended service. For example, for a cell guide system designed with horizontal supports at a spacing equivalent to the height of a standard container, a severe condition would be to assume a half height container in the first tier such that all of the horizontal forces are applied roughly midway between supports.

7.11 Carriage of 20-ft Containers in Cell Guides Designed for 40-ft Containers

7.11.1 General

20-ft containers may be carried in cell guides designed for 40-ft containers provided the requirements in 6/7.11.2 are met.

7.11.2 Arrangement

For 40-ft container cells that are also intended to periodically carry 20-ft containers, cones fixed to the tank top or similar arrangements are to be provided at the four corners of the cell in way of the guides. Also, means are to be provided at mid-cell to restrict transverse sliding of the bottom tier of the 20-ft container stacks. See 5/7.3.1 FIGURE 8. Container securing devices (e.g., stacking cones) are to be provided between each tier of the 20-ft containers and between the top tier 20-ft containers and an over-stowed 40-ft container to prevent transverse sliding between tiers. The loads on the securing devices between the tiers are not to exceed the safe working loads of these devices nor the container strength limits. The following two methods of securing the 20-ft containers may be employed.

7.11.2(a) Fore-and-aft double stacking cones may be fitted at mid-cell essentially forming the two 20-ft containers in each tier into an effective 40-ft container. In general, 20-ft containers with a maximum stack weight of 120 tonnes per stack may be stowed in this manner. Any additional positions available in the cell above the 20-ft containers may be filled with 40-ft containers up to the corner post compression limit of the lowest tier of 20-ft containers.

7.11.2(b) (1 September 2019)

Alternatively, for the second tier of 20-ft containers and above, stacking cones may be applied to the bottom corner fittings of the 20-ft containers before they are lifted aboard ship. In general, two 20-ft container stacks of equal height are to be stowed in the same row and supported by the forward and aft 40-ft cell guides.

If the 20-ft container stacks are not topped by 40-ft containers, the permissible weight of each 20-ft container stack (excluding the lowest tier) may be determined from 6/7.11.3 TABLE 2 for the given number of tiers and transverse acceleration at the roll center. If the 20-ft container stacks are topped by at least one 40-ft container, the permissible weight of each 20-ft container stack (excluding the lowest tier) may be determined from 6/7.11.3 TABLE 3. The weight of each 20-ft container is not to exceed its rating.

Sample Applications:

- (1) *20-ft Container Stack of 7 tiers without 40-ft container topping*
 The maximum transverse acceleration at the roll center = 0.45g
 Rating of 20-ft containers = 30.5 MT
 Allowable stack weight of 20-ft containers (above the lowest tier)
 = $(7 - 1) \times \min \{14.0, 30.5\} = 84$ MT
- (2) *20-ft Container Stack of 3 tiers with one 40-ft container topping*
 The maximum transverse acceleration at the roll center = 0.45g
 Rating of 20-ft containers = 30.5 MT
 Allowable stack weight of 20-ft containers (above the lowest tier)
 = $(3 - 1) \times 30.5 = 61.0$ MT

Alternate arrangements for the stowage of 20-ft containers in 40-ft container cells are to be specially considered.

The acceptance of the above loading methods is subject to national regulations of the port where vessel regularly visits for trading.

The corner post compression force in the lowest container is not to exceed the permissible compression value given in 3/5 TABLE 3 *Design Loads on Containers and Container Fittings*. The force in the corner post is obtained from the following formula:

$$F_V = \frac{A_{VMAX}(W_{T20ft} + W_{T40ft})}{4}$$

$$W_{T20ft} = \sum_{i=1}^{N_{20}-1} W_{20ft}(i)$$

$$W_{T40ft} = \sum_{j=1}^{N_{40}} W_{40ft}(j)$$

Where

- F_V = Compressive force in the corner post, in kN
- W_{T20ft} = Total weight of the 20-ft containers, in MT
- W_{T40ft} = Total weight of the 40-ft containers, in MT
- $N_{20} - 1$ = Total number of 20-ft containers in the stack, above the lowest tier
- N_{40} = Total number of 40-ft containers in the stack
- W_{20ft} = Allowable stack weight of 20-ft containers, in MT
- W_{40ft} = Allowable stack weight of 40-ft containers, in MT
- A_{VMAX} = Maximum Vertical Acceleration, in m/s^2

7.11.3 Shipboard Safety System

A fall protection system for personnel is required onboard the vessel when working on top of a container under the operating area of container gantry cranes. Unless a specific shipboard safety system is required by the port terminal union, where the vessel regularly visits for trading, the fall protection system shall be in compliance with the requirements specified in Appendix A1.

TABLE 2
Permissible Average Weight of 20-ft Containers Stowed in 40-ft Cell Guides (without 40-ft Container Topping) (1 September 2019)

<i>Transverse Acceleration (g)</i>	<i>Permissible Average Weight (MT)</i>									
	<i>3 Tiers</i>	<i>4 Tiers</i>	<i>5 Tiers</i>	<i>6 Tiers</i>	<i>7 Tiers</i>	<i>8 Tiers</i>	<i>9 Tiers</i>	<i>10 Tiers</i>	<i>11 Tiers</i>	<i>12 Tiers</i>
0.20g	30.5	30.5	30.5	23.6	21.3	19.6	18.9	17.8	17.1	16.4
0.21g	30.5	30.5	30.1	23.2	21.0	19.3	18.6	17.5	16.8	16.1
0.22g	30.5	30.5	29.5	22.8	20.6	19.0	18.3	17.2	16.5	15.8
0.23g	30.5	30.5	28.9	22.4	20.3	18.6	17.9	16.9	16.2	15.5
0.24g	30.5	30.5	28.3	22.0	19.9	18.3	17.6	16.6	15.9	15.2
0.25g	30.5	30.5	27.7	21.6	19.6	18.0	17.3	16.3	15.7	15.1
0.26g	30.5	30.5	27.1	21.2	19.2	17.7	17.0	16.0	15.4	14.8
0.27g	30.5	30.5	26.5	20.8	18.9	17.5	16.7	15.8	15.1	14.4
0.28g	30.5	30.5	25.9	20.5	18.6	17.2	16.4	15.5	14.9	14.3
0.29g	30.5	30.5	25.4	20.1	18.3	16.9	16.1	15.2	14.6	14.0
0.30g	30.5	30.5	24.8	19.7	17.9	16.6	15.9	15.0	14.4	13.8
0.31g	30.5	30.5	24.3	19.4	17.6	16.4	15.6	14.7	14.1	13.5
0.32g	30.5	30.5	23.8	19.0	17.3	16.1	15.3	14.5	13.9	13.3
0.33g	30.5	30.0	23.3	18.7	17.0	15.8	15.0	14.2	13.6	13.0
0.34g	30.5	29.3	22.8	18.4	16.8	15.6	14.8	14.0	13.4	12.8
0.35g	30.5	28.8	22.4	18.2	16.5	15.4	14.6	13.8	13.2	12.6
0.36g	30.5	28.2	21.9	17.9	16.2	15.1	14.3	13.6	13.0	12.4
0.37g	30.5	27.7	21.4	17.5	16.0	14.9	14.0	13.4	12.7	12.0
0.38g	30.5	27.1	20.9	17.2	15.7	14.6	13.8	13.1	12.5	11.9
0.39g	30.5	26.5	20.4	16.8	15.4	14.4	13.5	12.9	12.3	11.7
0.40g	30.5	25.9	20.0	16.4	15.1	14.1	13.3	12.6	12.1	11.6
0.41g	30.5	25.4	19.6	16.2	14.9	13.9	13.1	12.4	11.9	11.4
0.42g	30.5	24.9	19.2	15.9	14.7	13.7	12.9	12.2	11.7	11.2
0.43g	30.5	24.4	18.8	15.7	14.4	13.5	12.7	12.0	11.5	11.0
0.44g	30.5	23.9	18.4	15.4	14.2	13.3	12.5	11.8	11.3	10.8
0.45g	30.5	23.4	18.0	15.2	14.0	13.1	12.3	11.6	11.1	10.6
0.46g	30.5	23.0	17.7	15.0	13.8	12.9	12.1	11.5	11.0	10.5
0.47g	30.5	22.6	17.4	14.8	13.6	12.7	12.0	11.3	10.8	10.3
0.48g	30.5	22.2	17.1	14.6	13.4	12.5	11.8	11.1	10.6	10.1
0.49g	30.5	21.8	16.8	14.4	13.2	12.4	11.6	11.0	10.5	10.0
0.50g	30.5	21.4	16.4	14.2	13.0	12.2	11.5	10.8	10.3	9.8

Transverse Acceleration (g)	Permissible Average Weight (MT)									
	3 Tiers	4 Tiers	5 Tiers	6 Tiers	7 Tiers	8 Tiers	9 Tiers	10 Tiers	11 Tiers	12 Tiers
0.51g	30.5	21.1	16.2	14.0	12.8	12.0	11.3	10.7	10.2	9.7
0.52g	30.5	20.8	15.9	13.8	12.7	11.9	11.2	10.5	10.1	9.6
0.53g	29.5	20.4	15.6	13.6	12.5	11.7	11.0	10.4	9.9	9.4
0.54g	29.1	20.1	15.4	13.4	12.4	11.6	10.9	10.3	9.8	9.3
0.55g	28.6	19.7	15.1	13.3	12.2	11.4	10.7	10.1	9.6	9.1
0.56g	28.2	19.5	14.9	13.1	12.0	11.3	10.6	10.0	9.5	9.0
0.57g	27.8	19.2	14.6	13.0	11.9	11.1	10.5	9.9	9.4	8.9
0.58g	27.4	18.9	14.4	12.8	11.8	11.0	10.4	9.8	9.3	8.8
0.59g	27.0	18.6	14.2	12.7	11.6	10.9	10.2	9.7	9.2	8.7
0.60g	26.6	18.3	14.0	12.5	11.5	10.7	10.1	9.5	9.1	8.6
0.61g	26.3	18.1	13.8	12.4	11.4	10.6	10.0	9.4	9.0	8.6
0.62g	25.9	17.8	13.6	12.2	11.2	10.5	9.9	9.3	8.9	8.5
0.63g	25.6	17.6	13.4	12.1	11.1	10.4	9.8	9.2	8.8	8.4
0.64g	25.2	17.3	13.3	11.9	11.0	10.2	9.6	9.1	8.7	8.3
0.65g	24.9	17.1	13.1	11.8	10.9	10.1	9.5	9.0	8.6	8.2

Notes:

- 1 The lowest 20-ft container in the stack is included in the counting of 20-ft container tiers.
- 2 The weight of each 20-ft container is not to exceed its rating.

TABLE 3
Permissible Average Weight of 20-ft Containers Stowed in 40-ft Cell Guides (with 40-ft Container Topping) (1 September 2019)

Transverse Acceleration (g)	Permissible Average Weight (MT)									
	3 Tiers	4 Tiers	5 Tiers	6 Tiers	7 Tiers	8 Tiers	9 Tiers	10 Tiers	11 Tiers	12 Tiers
0.20g	30.5	30.5	30.5	30.5	30.5	29.5	26.2	23.5	22.1	20.7
0.21g	30.5	30.5	30.5	30.5	30.5	29.5	26.0	23.5	21.6	20.5
0.22g	30.5	30.5	30.5	30.5	30.5	29.3	26.0	22.9	21.5	20.1
0.23g	30.5	30.5	30.5	30.5	30.5	29.2	25.7	22.8	21.4	19.6
0.24g	30.5	30.5	30.5	30.5	30.5	29.0	25.6	22.8	21.0	19.4
0.25g	30.5	30.5	30.5	30.5	30.5	29.0	25.6	22.7	21.0	19.2
0.26g	30.5	30.5	30.5	30.5	30.5	28.8	25.5	22.7	20.9	19.1
0.27g	30.5	30.5	30.5	30.5	30.5	28.7	25.4	22.6	20.8	19.1
0.28g	30.5	30.5	30.5	30.5	30.5	28.5	25.2	22.6	20.8	19.0
0.29g	30.5	30.5	30.5	30.5	30.5	28.0	25.1	22.5	20.7	19.0

Transverse Acceleration (g)	Permissible Average Weight (MT)									
	3 Tiers	4 Tiers	5 Tiers	6 Tiers	7 Tiers	8 Tiers	9 Tiers	10 Tiers	11 Tiers	12 Tiers
0.30g	30.5	30.5	30.5	30.5	30.5	27.4	24.9	22.5	20.7	19.0
0.31g	30.5	30.5	30.5	30.5	30.2	26.8	24.4	22.0	20.4	18.9
0.32g	30.5	30.5	30.5	30.5	29.6	26.4	23.9	21.6	20.0	18.4
0.33g	30.5	30.5	30.5	30.5	29.0	25.8	23.3	21.2	19.7	18.3
0.34g	30.5	30.5	30.5	30.5	28.4	25.4	22.9	20.7	19.4	18.1
0.35g	30.5	30.5	30.5	30.5	28.0	24.9	22.6	20.6	19.0	17.4
0.36g	30.5	30.5	30.5	30.5	27.4	24.5	22.0	20.2	18.7	17.3
0.37g	30.5	30.5	30.5	30.5	26.8	23.9	21.6	19.7	18.4	17.1
0.38g	30.5	30.5	30.5	30.3	26.2	23.5	21.2	19.3	18.0	16.7
0.39g	30.5	30.5	30.5	29.7	25.8	22.9	20.7	18.9	17.7	16.5
0.40g	30.5	30.5	30.5	29.1	25.2	22.5	20.3	18.6	17.4	16.2
0.41g	30.5	30.5	30.5	28.6	24.8	22.0	20.0	18.1	17.1	16.1
0.42g	30.5	30.5	30.5	28.1	24.4	21.6	19.6	17.8	16.8	15.8
0.43g	30.5	30.5	30.5	27.6	23.9	21.2	19.3	17.5	16.5	15.5
0.44g	30.5	30.5	30.5	27.1	23.5	20.7	18.9	17.3	16.2	15.2
0.45g	30.5	30.5	30.5	26.5	23.1	20.4	18.6	17.0	16.0	14.9
0.46g	30.5	30.5	30.5	26.1	22.6	20.0	18.1	16.7	15.8	14.7
0.47g	30.5	30.5	30.5	25.7	22.3	19.7	17.8	16.5	15.5	14.5
0.48g	30.5	30.5	30.2	25.2	21.9	19.4	17.5	16.2	15.4	14.4
0.49g	30.5	30.5	29.6	24.9	21.6	19.0	17.3	16.0	15.1	14.2
0.50g	30.5	30.5	29.1	24.5	21.2	18.7	17.0	15.8	14.8	13.8
0.51g	30.5	30.5	28.7	24.1	20.9	18.4	16.7	15.5	14.6	13.7
0.52g	30.5	30.5	28.3	23.8	20.6	18.1	16.5	15.4	14.5	13.6
0.53g	30.5	30.5	27.8	23.3	20.2	18.0	16.2	15.1	14.2	13.3
0.54g	30.5	30.5	27.4	23.1	19.9	17.7	16.0	14.9	14.1	13.2
0.55g	30.5	30.5	27.0	22.6	19.6	17.4	15.8	14.6	13.8	12.9
0.56g	30.5	30.0	25.4	22.1	19.6	17.1	15.6	14.4	13.3	12.4
0.57g	30.5	29.2	24.7	21.5	19.1	16.8	15.3	14.3	13.3	12.4
0.58g	30.5	28.8	24.3	21.2	18.8	16.7	15.0	13.8	12.8	11.9
0.59g	30.5	28.6	24.2	21.0	18.6	16.4	14.6	13.5	12.5	11.6
0.60g	30.5	27.2	23.0	20.1	17.7	16.1	14.5	13.2	12.4	11.5
0.61g	30.5	27.1	23.0	20.0	17.5	16.0	14.3	13.1	12.2	11.3
0.62g	30.5	27.0	22.9	19.8	17.2	15.7	14.2	13.1	12.2	11.3
0.63g	30.5	25.8	21.8	18.9	16.8	15.5	14.1	13.1	12.0	11.3

Transverse Acceleration (g)	Permissible Average Weight (MT)									
	3 Tiers	4 Tiers	5 Tiers	6 Tiers	7 Tiers	8 Tiers	9 Tiers	10 Tiers	11 Tiers	12 Tiers
0.64g	30.5	25.7	21.7	18.6	16.5	15.4	14.0	12.9	11.9	11.2
0.65g	30.5	25.0	21.2	18.4	16.3	15.2	13.7	12.6	11.6	10.8

Notes:

- 1 The lowest 20-ft container in the stack is included in the counting of 20-ft container tiers.
- 2 The weight of each 20-ft container is not to exceed its rating.
- 3 40-ft topping containers are not included in the number of tiers in this table.

7.13 Other Rigid Securing Systems

Other systems which rigidly support containers and provide lateral restraint against forces due to the ship motions or wind loads are to be separately considered.

7.15 Combining Securing Systems

Most securing systems are generally applied at both ends of a container stack. However, there may be stowage arrangements which, for flexibility or other reasons, utilize different systems at each end. The interaction between systems which might impact the permissible stack weight is to be specially considered. When such an analysis is not practical, the permissible stack weight and container weight at each tier are to be based on the requirements of the securing system that provides the lowest permissible container weights.

7.15.1 Rigid and Flexible Securing Systems

When combining a rigid securing system, such as cell guides, at one end with a flexible lashing system at the other end, the stack ratings would be based upon the lashing system.

If one system, by design, supports a greater portion of the lateral load, acceptance is to be based on a review of supporting documents and calculations.

7.15.2 Two Flexible Securing Systems

Some stacks of containers may be secured with different flexible securing systems at each end. For example, a stack of containers may be secured using cross lashing assemblies at one end but only twistlocks at the other end. The permissible stack ratings are to be determined by the lowest rated system. In this example, the permissible container stowage weights would be based on a twistlocked stack.

7.17 Block Stowage

The forces and loads on containers stacked and secured in blocks shall be determined from 6/3. The assessment of this type of stowage arrangement shall be specially considered and shall reflect:

- The strength and flexibility of the containers
- The strength, interaction, and tolerance of the fittings connecting adjacent stacks
- The flexibility and strength of the buttress fittings, including their ability to support both tensile and compressive loads

9 Acceptance Criteria

9.1 General

For each stowage arrangement, the permissible stack rating is to be governed by the permissible loads in the containers at each tier, in the securing fittings, and in the fixed or rigid support elements.

9.3 Containers

Container loads are not to exceed the design loads given in 3/5 TABLE 3. As noted in 3/9, higher strength ratings are to be specially considered when verified by formal testing as described in the *ABS Rules for Certification of Cargo Containers*.

9.5 Securing Fittings

Loads in securing fittings are not to exceed the safe working load of the fitting based upon the safety factors presented in 4/7.1 TABLE 3 and the minimum breaking strength determined by testing. Values for the SWL and MBS shall be given on an ABS test certificate provided by the manufacturer for each fitting and included in the Cargo Securing Manual.

9.7 Fixed Cell Guides, Shoring, Buttresses and Other Rigid Supports

Loads in these components and attached hull structure shall not exceed the following permissible stresses:

$$f = 0.80Y$$

$$q = 0.53Y$$

where:

f = maximum normal stress, in kN/cm^2 (Ltf/in^2)

q = nominal permissible shear stress, in kN/cm^2 (Ltf/in^2)

Y = minimum specified yield point of the material, in kN/cm^2 (Ltf/in^2)

For higher strength steels, Y is not to be taken as greater than 72% of the specified minimum tensile strength.

11 Design Considerations for Hull Structure

11.1 Design Loads

Calculated securing forces are to be less than the safe working load of the fitting. When evaluating the support structure for fixed securing fittings, the assessment shall be based on the maximum safe working load or container design load (from 3/5 TABLE 3). For example, even if the vertical compression at the base of a stack is determined to be less than maximum allowable vertical compression, the structure immediately below the twistlock foundation or base socket is to be based on the maximum allowable rather than the calculated, lesser value.

11.3 Allowable Stresses

Allowable stresses for evaluating hull structure are to be determined from the pertinent sections of the *ABS Rules for Building and Classing Marine Vessels*, including Part 3, "Hull Construction and Equipment" and Part 5C, Chapter 5, "Vessels Intended to Carry Containers".

SECTION 7 Materials and Welding

1 General

Materials for container securing devices permanently attached to the hull structure are to be documented by tests and witnessed by a Surveyor unless the manufacturer is approved under an ABS Quality Assurance Program. The material physical properties are to be compatible with the hull materials in way of the attachment, and the chemical composition is to be such as to ensure welds of acceptable quality. Securing devices may be accepted on the basis of testing and inspection as specified in Section 8.

3 Materials

The requirements in this Section are applicable to rolled steel, cast, and forged material used for container securing devices. The general guidelines and requirements defined in the *ABS Rules for Materials and Welding (Part 2)* are to be applied, unless there are specific requirements in this Guide.

3.1 Rolled Steel

For shapes and plates used in the construction of cell guides, buttress towers, container foundations on deck, etc., the steel is to satisfy the requirements for hull steels specified in the *ABS Rules for Materials and Welding (Part 2)*.

Other structural steels are to be subject to special consideration.

3.3 Cast and Forged Securing Components

Steel castings and forgings are to be in accordance with the requirements of the *ABS Rules for Materials and Welding (Part 2)* or an acceptable equivalent specification. Use of high strength and alloy steels is to be subject to special consideration.

Ferritic nodular cast iron may be used for loose gear not subject to welding.

3.5 Chain

Unstudded short-link chain is to be in accordance with 2-2-2/25.1 of the *ABS Rules for Materials and Welding (Part 2)*.

Other chains are to be specially considered.

5 Welding

Welding is to be in accordance with Chapter 4 of the *ABS Rules for Materials and Welding (Part 2)*. Alternate welding procedures and specifications are to be specially considered.

For cast or forged securing elements which are to be welded, the carbon content is not to exceed 0.35% unless specially approved.

7 Impact Properties

Container securing devices used at low temperatures are to have adequate fracture toughness. For container securing devices intended to be used at design service temperature of -10°C and below, the materials are to be tested for Charpy impact properties unless the parts are subject to compressive stresses only without any tension or shear stresses. The design service temperature is to be taken as the lowest mean daily average air temperature in the area of operation. The requirements for the preparation and procedure of a Charpy V-notch impact test are defined in 2-1-2/11 of the *ABS Rules for Materials and Welding (Part 2)*. Charpy impact properties are tested at a temperature 10°C below the design service temperature. The results of the test are to meet the requirements specified in Section 2 of the *ABS Guide for Vessels Operating in Low Temperature Environments*.

Testing, Inspection, and Approval of Securing Devices**1 Drawings**

Drawings of container securing devices and fittings showing dimensions, materials, testing procedures, and manufacturer's markings are to be submitted for approval according to the requirements in this Guide. The design breaking loads, proof loads, and safe working loads are to be clearly indicated on the drawings. Proof loads are not to be less than 1.1 times the safe working loads for individual pieces.

3 Testing**3.1 Prototype Testing (1 July 2016)**

Prior to testing, the Surveyor is to verify that the materials, dimensions, and assembly of the test pieces are in accordance with the approved drawings.

In the presence of the Surveyor, prototypes of each securing device and fitting are to be tested to and withstand the design breaking loads indicated on the drawing. Three samples of a securing device are to be tested for each applicable loading: tension, compression, and shear. The tests are to simulate, as closely as practical, actual service conditions. No permanent deformation of the tested device or the structure to which it is attached is permissible up to the proof load indicated on the approved drawings. The prototype tests required for typical securing devices are given in 8/7.7 TABLE 1.

Fully automatic twistlocks are also to be functionally tested in accordance with the test procedure described in Appendix A4, "Prototype Function Test Procedure for Fully Automatic Twistlocks".

The Surveyor will issue a test report upon satisfactory completion of the prototype tests.

3.3 Production Testing

Container securing devices to be used as part of a securing system are to be tested in accordance with the following Subparagraphs.

3.3.1 General

Castings and forgings are to be inspected by the Surveyor to ensure that they are free from defects. Samples of adjustable securing devices such as turnbuckles, twistlocks, etc. are to be checked for ease of operation.

3.3.2 Proof Tests

For all container securing devices, except lashing wire or chain, a sample of one (1) piece in fifty (50) is to be tested, in the presence of the Surveyor, to the proof load indicated on the drawing. For items produced in quantities of less than fifty (50), one (1) sample is to be proof tested. After

testing, the securing component is to be examined and verified free from damage or permanent deformation.

Securing devices need not be proof tested in compression.

3.3.3 Breaking Tests

In the presence of the Surveyor, lashing devices and bridge struts are to be tested to the design breaking load indicated on the drawing, as follows.

- 1 Lashing wire and chain, one (1) piece in fifty (50)
- 2 Bridge struts and other lashing devices such as rods, turnbuckles and lashing points, one (1) piece in two hundred fifty (250).

For items produced in quantities less than those indicated, one sample is to be break tested. Securing devices subjected to breaking tests are to be discarded.

The Surveyor will issue a test report upon satisfactory completion of the production tests. This report is to include the name of the vessel on which the gear is to be employed, if available. For each type of securing device and fitting, the following information is to be included: the number of devices in the production run, the number of devices proof tested with proof loads indicated, and the number of devices break tested with design breaking load indicated.

5 Marking of Securing Devices

All container securing devices are to be permanently marked with the manufacturer's name and identification number.

7 Type Approval

7.1 General

The Type Approval includes Product Design Assessment (PDA) review and Survey Testing/Manufacturing Assessment (MA). The Type Approval Certificate is to be issued upon satisfactory completion of the PDA review and MA assessment, which are to be listed on the ABS website, www.eagle.org under "List of Type Approved Equipment".

7.3 Product Design Assessment (PDA) Review

The Product Design Assessment (PDA) review requires both the product design plan review and prototype testing. The product design plan review is engineering evaluation of the product design for meeting design specifications indicated in Section 4. The Surveyor needs to witness prototype testing indicated in 8/3.1. Upon satisfactory completion of the design review and the prototype testing, a Product Design Assessment (PDA) Certificate is to be issued by ABS engineering office. The PDA normally would have a 5-year validation. When the device is specified for a specific hull, drawings of the device need not be submitted for review again after obtaining the PDA, prototype testing is dispensed with, and the manufacturer may carry out and maintain records of the production testing indicated in 8/3.3.

7.5 Quality Assurance

With valid PDA certificate of the products, all manufacturers of the products with the same design are required to be audited by the Surveyor. The manufacturers include their subcontractors such as all welding shops.

The Surveyor is to evaluate the quality assurance and quality control system of the manufacturing facilities in order to assess and verify their capability to meet the manufacturer's specified level of product quality consistently and satisfy the requirements of the Rules, as applicable.

The Surveyor is also to evaluate the product specific manufacturing process of the manufacturer in order to assess and verify that manufacture and inspections of the products are established to provide the manufacturer's specified level of quality control, and to satisfy the requirements of the Rules.

Upon satisfactory completion of the evaluations, a Manufacturing Assessment (MA) Certificate may be issued. There will then be an annual inspection of the plant's quality control and production testing system.

7.7 Type Approval Certificate (1 August 2024)

The Type Approval Certificate can be issued based on valid PDA and MA for the products of container securing devices and fittings. The Type Approval Certificate will indicate the following items.

- i) Name and identification number of the part
- ii) Manufacturer's name and location, which include all welding and subcontracting shops
- iii) Materials
- iv) Test report No. and name
- v) Minimum breaking loads, proof loads and safe working loads.

In addition for fully automatic twistlocks:

- vi) Minimum twistlock pull out force, twistlock maximum vertical clearances:
 - a) Without load,
 - b) At SWL, and
 - c) At $1.1 \times$ SWL in accordance with the functional tests in A4/7.3.2.
- vii) **The vertical clearance at SWL to be used in lashing calculations as in A4/7.3.3.**

TABLE 1
Required Prototype Tests (1 July 2016)

<i>Item No.</i>	<i>Securing Devices</i>	<i>Tension</i>	<i>Compression</i>	<i>Shear</i>	<i>Notes</i>
1	Lashing (Wire, Chain & Rod)	X			
2	Tensioning Device	X			e.g., turnbuckle
3	"Penguin" Hook			X	Also bending test
4	Lashing Point	X			1. Test loads to be oriented at working angle of lashing. 2. For lashing points with multiple openings, simultaneous test loads are to be applied if simultaneous loads occur in service.

<i>Item No.</i>	<i>Securing Devices</i>	<i>Tension</i>	<i>Compression</i>	<i>Shear</i>	<i>Notes</i>
5	Lock Fitting	X		X	e.g., twistlock Twistlock breaking load tests are to be performed by a testing machine in which the two fittings holding the twistlock are equivalent to the ISO corner castings. For the tensile test, the tension test jig must also prevent transverse, longitudinal and rotational movements of the twistlock under test. In addition fully automatic twistlocks are to be tested in accordance with the test procedure described in Appendix A4, Prototype Function Test Procedure for Fully Automatic Twistlocks (FATs). Novel concepts or features of FATs for which the Prototype Function Test Procedure may not be directly applicable shall be specially considered. Consultation with ABS is to be made on the testing procedure with special consideration given to testing requirements of the novel concepts or features prior to the prototype testing.
6	Single Stacking Cone			X	
7	Double Stacking Cone	X			Test to be set up such that loading is applied through cones.
8	Base Socket - Flush	X	X		For sockets with multiple openings, simultaneous test loads are to be applied if simultaneous loads occur in service. If headers are to be welded directly to the socket supporting each socket opening, however, only one opening need be tested.
9	Base Socket - Raised	X	X	X	See Note, Item 7
10	Base Socket - Breech Base or "Dove Tail"	X		X	See Note, Item 7
11	Bridge Fitting	X			
12	Bridge Strut	X	X		Test to be set up such that loading is applied through cones.

SECTION 9 Container Securing Manuals

1 General

A Container Securing Manual (the “Manual”) is to be prepared and submitted for approval. This manual serves as the official Cargo Securing Manual for the vessel as required by SOLAS and the IMO Code of Safe Practice for Cargo Stowage and Securing (Refs. 6 - 8). All containers shall be stowed and secured throughout the voyage in accordance with the Manual. A copy of the Manual, approved by ABS on behalf of the Flag Administration, is to be retained onboard the vessel for examination and/or reference by ABS Surveyors, Port/Flag State inspectors, and those involved with safe stowage and securing of cargoes carried.

In general, the items identified in the following sections are to be included in the Manual. However, nothing in this Section of the Guide replaces or alters the requirements of the SOLAS Convention or Code.

3 Contents of the Container Securing Manual

An acceptable Manual shall at the minimum, include the following information addressing stowage and securing of containers. If the vessel carries semi-standardized cargo (packaged goods, vehicles, trailers, etc.) or non-standardized cargo (project cargo) stowage guidance as required by the IMO Code (Ref. 2) is also to be provided.

3.1 General

The following points describe how the Manual is to be developed, used, maintained, and updated. These points shall be included in Chapter 1, “General” of the Manual:

- The guidance given herein shall by no means rule out the principles of good seamanship, neither can it replace experience in stowage and securing practice. The Master shall ensure that cargo carried in the vessel is stowed and secured in a proper manner, taking into account prevailing conditions and the general principles of safe stowage.
- The information and requirements set forth in this Manual are consistent with the requirements of the vessel’s trim and stability booklet, International Load Line Certificate (1966), the hull strength loading manual (if provided) and with the requirements of the International Maritime Dangerous Goods (IMDG) Code (if applicable).
- This Container Securing Manual specifies arrangements and container securing devices provided onboard the vessel for the correct application to and the securing of containers, based on transverse, longitudinal and vertical forces which may arise during adverse weather and sea conditions, as well as the strength of the container, securing devices and vessel structure. The purpose of this Manual is to provide guidance to the Master and crew on board the vessel with respect to the proper stowage and securing of containers throughout the voyage.

- It is imperative to the safety of the vessel and the protection of the cargo and personnel that the securing of the containers is carried out properly and that only appropriate securing points or fittings should be used for cargo securing.
- The container securing devices mentioned in this manual should be applied so as to be suitable and adapted to the quantity, type, and physical properties of the containers to be carried. When new or alternative types of container securing devices are introduced, the Container Securing Manual should be revised accordingly. Alternative container securing devices introduced should not have less strength than the devices being replaced.
- There should be a sufficient quantity of reserve container securing devices onboard the vessel.
- Information on the strength and instructions for the use and maintenance of each specific type of container securing device, where applicable, is provided in this manual. The container securing devices should be maintained in a satisfactory condition. Items worn or damaged to such an extent that their quality or operability is impaired should be replaced.
- The information contained in this Manual is in an approved form in accordance with MSC/Circ 745, Guidelines for the Preparation of the Cargo Securing Manual (Ref. 8). This Manual has been prepared in accordance with the International Convention for the Safety of Life at Sea, 1974 (SOLAS), Chapters VI and VII (Ref. 6), and the IMO 2003 Edition of the Code of Safe Practice for Cargo Stowage and Securing, (Ref. 7).
- A copy of this Manual, approved by ABS on behalf of the Flag State, shall be retained onboard the vessel for examination or reference by ABS Surveyors, Port/Flag State inspectors, and those involved with safe stowage and securing of cargoes carried.
- In the event the provisions of this Manual are revised, or the container securing devices described herein are significantly modified or altered, this Manual shall be revised and resubmitted for review and approval by ABS. All such changes are to be documented as Revisions.

3.3 Container Stowage Arrangements

Each container stowage location on the vessel is to be identified, and the characteristics of each cell provided. This can be done in the form of drawings, sketches, or tables of information. At a minimum, the following should be included.

- Container Arrangement Plan showing IMO bay/stack/tier numbering and all possible container stowage configurations (optional lengths, heights, overstows, etc.)
- Capacity tables giving total slot capacities in applicable container stowage configurations
- Visibility restrictions at a range of drafts and trim
- Hazardous cargo stowage locations, limitations and required segregations as applicable
- Clear heights in holds
- Location of refrigerated container stowage locations and outlets
- Section diagrams showing each unique stack configuration and stack base height

3.5 Fixed and Portable Securing Components

3.5.1 Description and Storage of Securing Components

A list of all securing equipment shall be provided with a sketch of each component, its key dimensions, material, manufacturer's identification number, and quantity. Class Type Approval certificates are to be provided for each securing component showing the minimum breaking strength, proof load, and safe working load for each type of applicable design load - tension, compression and/or shear. In case Type Approval is not available, a prototype test report will be acceptable, see 8/3.1.

The location of each fixed securing device in holds and on deck shall be shown in a drawing or table.

A list of all tools and accessories for use with the securing components shall be provided.

3.5.2 Inspection and Maintenance of Securing Components

Instructions shall be given for inspection, maintenance, and lubrication of securing components. All components shall be inspected and inventoried regularly. If any components are found defective, they shall be marked and removed from service. Inspections, inventory, and ordering of replacement of portable securing components shall be recorded in an Inspections and Maintenance Log. When overhauled or repaired securing components are received they shall be inspected and an entry made in the log book.

Fixed cargo securing devices shall be visually inspected annually for damage such as cracking or deformation. In way of fixed cargo securing devices, vessel's structure that is visible shall also be inspected regularly for damage such as cracking or deformation. This is to include hatch cover structure (such as top plates in way of base sockets, and girders and beams under base sockets) and cell guides.

3.5.3 Use and Installation of Securing Components

The Manual shall include sketches and descriptions that show how each portable securing component is used. This includes installation, locking or tightening, unlocking, handling, and storage. It is especially important to include notes on how to determine if securing components are fully locked and engaged, or unlocked.

For vessels with platforms or other fixed means of access to container stacks that are used for lashing or reefer maintenance, guidance on the use of portable hand railings, lights, and other safety features shall be provided.

3.5.4 Hatch Cover Arrangement, Weight, and Stacking

It is quite useful to include information about the hatch covers in the Manual, such as hatch cover weights and guidance for stacking covers on the quay or on other covers.

3.7 Diagrams of Approved Container Securing Systems

Diagrams of available and approved securing systems for stacks of containers on deck and in holds that show the proper use of the securing components are to be provided. This shall include all available lashing patterns (single lashing, double lashing, no-lashing, etc.) and indications of where these can be used (for example, only outboard stacks, at ends of paired 20-ft containers, from lashing bridges, etc.). Container stowage arrangement plans for each hold, hatch cover, or stowage location can be shown with securing devices indicated. Alternatively, "typical" views of container stacks, such as those in 9/3.7 FIGURE 1, may be employed where appropriate.

FIGURE 1
Sample Stack Securing Diagram

(The circled notations suggest one method of linking the sample stack diagram with a detailed list of available fittings.)

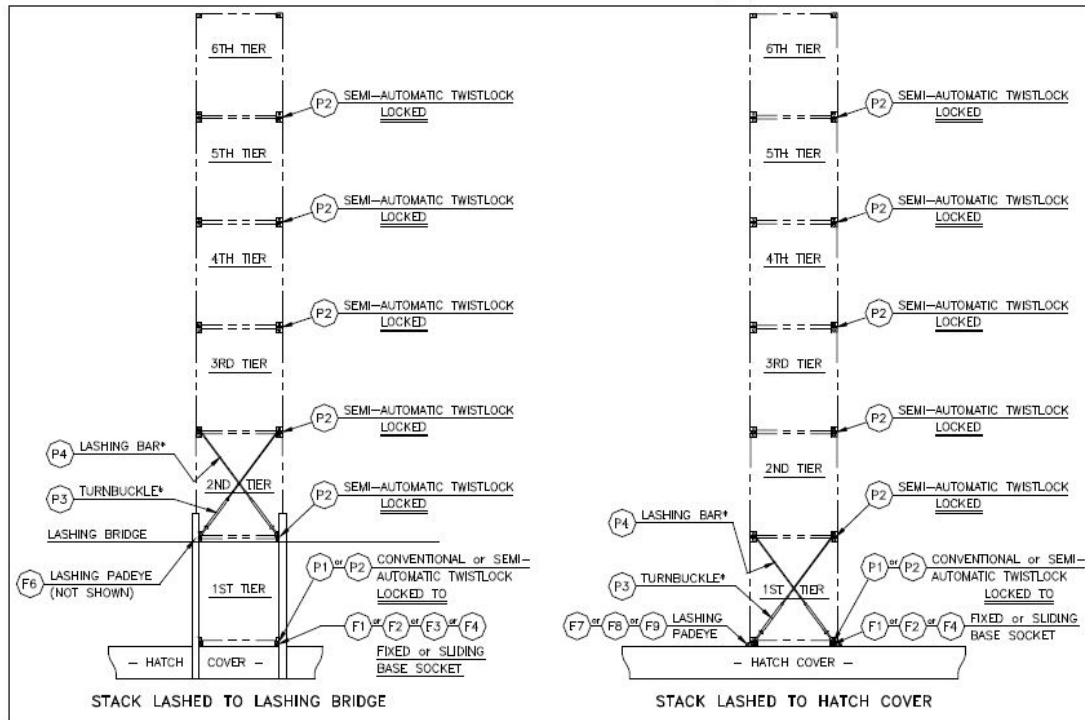

3.9 Presentation of Permissible Container Stack Weights

Container stack weights are limited by the strength of the hull structure and the securing system (which includes the container itself). For the most part, stack weight limits defined by hull structure and rigid securing systems (such as cell guides) do not change with operating condition characteristics (such as GM) or stack configuration. The maximum permissible gross stack weight imposed due to the strength consideration to the hull structure for each stack onboard are to be provided in the Manual. It is to be noted in the Manual that the maximum permissible stack weight can vary greatly depending on location (on hatches or in hold cell guides for instance) or container length (20-ft vs. 40-ft containers, etc.)

Stack weight limits imposed by the securing system for free standing stacks lashed with flexible securing systems are dependent on many factors, including the following:

- Vessel characteristics and loading condition (length, beam, draft, and GM)
- Stack location onboard
- Stack configuration (type, number, and size of containers and how they are connected)
- Container strength and stiffness
- Lashing configuration
- Lashing component strength and stiffness
- Exposure to wind
- Container weights within the stack

The number of solutions possible with so many input variables is considerable, resulting in a wide range of allowable stack weights for the available lashing configurations.

It is also recognized that there is an operational imperative to keep the lashing as simple as possible to minimize time and cost in port. Therefore, it is essential that the Manual present clear and explicit guidance on permissible stack weights that cover the normal range of operating conditions, and stack and lashing variables noted above. This guidance shall permit the vessel's crew to assess the acceptability of applied securing systems to each stack considering the actual container weights, stack location, GM, and wind exposure. Where approximations or assumptions are required to limit the information to a manageable level in the Manual, the resulting guidance shall be prudently conservative in nature.

Direct and precise calculations of permissible stack weights for each stack using actual values instead of simplifying assumptions may be performed by a suitable computer program that uses the methodologies defined in this Guide. Refer to 9/3.9.4.

3.9.1 Presentation of Stack Weight Limits Due to a Flexible Securing System (1 July 2016)

In general, the Manual is to include diagrams of each possible stack and lashing configuration for every location onboard along with the allowable container weights in each tier. If a certified computer lashing program (see Appendix A3) is installed onboard, the locations of the diagram may be reduced with a minimum of three bays – one for each from forward bay, midship bay, and aft bay. The format is to allow the crew to quickly assess lashing requirements for operating conditions they may encounter in service.

Permissible container weights for homogenous (all containers of equal weight) and stratified (weights decrease in higher tiers) container stacks are to be provided. Results are to be provided for a normal full load GM, part load (higher) GM, and one intermediate GM. For reference, representative GM ranges for typical ship breadths are listed below:

<i>Beam</i>	<i>GM Range</i>
≤ 32.2 m	0.5 m ~ 3.0 m
> 32.2 m	0.8 m ~ 4.0 m
> 37 m	1.0 m ~ 5.0 m
> 40 m	1.0 m ~ 6.0 m
> 42 m	1.0 m ~ 7.0 m
> 48 m	1.0 m ~ 8.0 m

Permissible stack weights for each GM shall be applicable for all operating conditions with a lower GM. The higher GM shall be selected to represent a near upper bound on all possible operating conditions because it represents an upper bound on the loads that are not to be exceeded.

3.9.2 Background Information for Calculated Stack Weight Limits

The values used to determine the permissible stack weights presented in the Manual as discussed in 9/3.9.1 shall also be provided in the Manual. This is to inform the crew and also allow verification calculations to be performed with all the correct data.

At least the following information should be included

- The drafts and GMs assumed
- The calculated maximum roll and pitch angles, and roll, pitch, and heave periods
- A note regarding the transverse, vertical, and longitudinal accelerations applied at each tier and stack should be derived from the Guide or from other sources.

- The container and lashing assembly strength ratings and spring constants
- The lashing assembly geometry and any movement or sliding due to vessel hull torsional deflection, hatch cover movement or lashing bridge flexibility
- Container geometries assumed (heights) and stack configuration
- The applied wind load
- Any deviations from other assumptions or calculation methodology presented in this Guide

3.9.3 Assessing Stack Weight Limits for Alternative Stack Configurations

In order to help the crew assess the stack weight limits and securing requirements for stacks that deviate from the configurations presented as described in 9/3.9.1, general guidance shall be provided that discusses the impact of variability in the input parameters. Providing sample stacks with maximum weights that result from altering each of the following parameters one at a time is suggested.

- *GM*: Consider a higher GM as an upper bound on forces and accelerations.
- *Wind Exposure*: Consider 1, 2, or 3 of the upper tiers exposed in an otherwise wind protected stack.
- *Stratification*: Consider reverse stratified stacks with heavier containers above lighter ones.
- *Container Strength and Stiffness*: Consider special containers with greater flexibility (such as open ended containers or containers with one door removed) or lower strength ratings.

Discussion of the results of these variations and rules of thumb, such as the following, shall also be provided.

- The higher the GM, the greater the forces acting on the containers. If the vessel is partially loaded and has a particularly high GM, loads on the containers and securing system can increase significantly.
- Weather effects increase the loading into the containers and lashing components. For tall stacks, the wind load on the upper tiers that may be exposed imposes an overturning moment which can significantly increase the tension and compression in the bottom container of an otherwise wind protected stack.
- The location of the stack has an influence on the accelerations and forces acting on the containers. Stacks located at the ends of the vessel experience the highest accelerations. Outboard stacks experience higher accelerations than inboard stacks.
- The container strengths do vary, particularly the values for corner-post tension and corner-post compression.
- Raising portions of the stack by using taller containers in lower tiers will increase the acceleration loads on the stack and reduce the permissible weights.
- Forces into the lashing system and containers are reduced when the stack is vertically stratified, with the heaviest containers located in the lower tiers. Reducing the weight of containers in the bottom tiers, even if still heavier than containers above, can increase loads into the container and/or securing system.
- Expected accelerations are based on extreme sea states and unrestricted service. Operation in near coastal waters or calm weather will result in lower accelerations and higher permissible stack weights.
- The maximum safe working load (SWL) of the lashing assembly is taken at 50% to 60% of the minimum breaking strength (MBS).

Because generally conservative assumptions are included in the calculation methodology, it is possible to apply the simplified permissible stack weights to actual stacks if the crew is alerted to the limitations of the assumptions and effect of differences from the assumed values as described above.

3.9.4 Lashing Calculations by Computer Based Programs (1 July 2016)

It is quite common for vessel stow planning to be done with an onboard computer lashing program that can calculate the maximum permissible stack weights for each individual stack based on the provided container lashings. If such a program is used, it shall be certified based on the methods and assumptions of this Guide and be referenced and described in the Container Securing Manual. A computer lashing program onboard a vessel having an installed container securing system certified by ABS is to be certified in accordance with Appendix A3 of this Guide, and the vessel assigned the notation **CLP** for computer lashing program. A certified onboard computer lashing program is mandatory if it is also capable of performing calculations for specific voyage routes to obtain possible reduction in accelerations, see 6/3.7.3. The suffix **V** shall be added to the computer lashing program notation, **CLP-V**, to signify the certification of the computer lashing programs capability to address both unrestricted service and specific voyage routes.

The Manual shall include sample stack weight calculations from the program and provide full documentation of assumptions so that the calculations can be checked. These sample cases could also be used periodically to confirm the results provided to the vessel from a shore side planner.

A separate supporting document is to be prepared that describes the computer lashing program and assumptions, and provides calculation examples as described in A3/5. This document is to be submitted for review when the Manual is submitted for review and approval. The supporting document is to also be placed on board the vessel as background for the crew.

The container weight limits given by the computer lashing program are to be strictly followed in practice.

1 Initial Installation Survey (2024)

All work is to be in accordance with approved plans and the Surveyor is to be satisfied with the materials, workmanship, and welding procedures employed during initial installation. Production test reports and either Type Approval Certificates or prototype test reports attesting to the strength of the fittings, lashings, and tensioning devices, etc. are to be obtained and reviewed for completeness and accuracy. All components are to be checked for consistency with the approved Container Securing Manual.

Where the **CLP-V(PARR)** notation is requested, the functionality of the digital onboard operational guidance for parametric roll detection and prevention are to be verified by confirming:

- i)* The approved operational guide is on board.
- ii)* User interface is tested based on the approved operational guide.
- iii)* Verification of graphical display with the polar diagram or other pre-calculated database.

Upon satisfactory completion of this survey an Initial Installation Survey Certificate will be issued by the Surveyor.

3 Container Securing Manual

An approved copy of the Container Securing System Manual as noted in Section 9, copies of the Type Approval Certificates or prototype test reports, copies of production test reports covering all the securing gear, and the Initial Installation Survey Certificate are to be carried aboard the vessel for use by the vessel's personnel.

5 Maintenance in Service

The proper maintenance of the container securing equipment in service does not rest upon ABS.

APPENDIX 1 Shipboard Safety Systems

1 General

Unless protection system components are certified by a recognized national standard, the ABS Type Approval Program may be applied for the certification.

Each fall protection system component, except anchorages, is to have fall arrest/restraint as its only use.

3 Design

Fall protection system components are to be certified as a unit that is capable of sustaining at least twice the potential impact load of a person's fall. Each fall protection system adopted for use shall have an energy absorbing mechanism that will produce an arresting force on a person of not greater than 8 kN (816 kgf, 1800 lbf). Each component of a fall protection system shall be designed and used to prevent accidental disengagement. Each fall protection system's fixed anchorages are to be capable of sustaining a force of 22.2 kN (2268 kgf, 5,000 lbf) or be certified as capable of sustaining at least twice the potential impact load of a person's fall. When more than one person is attached to an anchorage, these limits are to be multiplied by the number of personnel attached.

5 Arrangement

Each fall protection system is to incorporate the use of a full body harness. Each device, such as a safety cage, used to transport personnel by being attached to a container gantry crane spreader, is to have a secondary means to prevent accidental disengagement and the secondary means shall be engaged.

7 Operation

Each fall protection system subjected to impact loading is to be immediately withdrawn from service and not be used again until inspected and determined by a designated person to be undamaged and suitable for use.

Each fall protection system is to be rigged so that a falling person will not reach to any lower level stowage or vessel structure. Each fall protection system is to be inspected before each day's use by a designated person. Any defective components are to be removed from service. Before using any fall protection system, the personnel are to be trained in the use and application limits of the equipment, proper hookup, anchoring and tie-off techniques, methods of use, and proper methods of equipment inspection and storage. The operator is to establish and implement a procedure to retrieve personnel safely in case of a fall.

9 Anchorage

When "live" (activated) container gantry crane lifting beams or attached devices are used as anchorage points, the following requirements apply:

- i) The crane is to be placed into a "slow" speed mode;

- ii)** *(1 April 2014)* The crane is to be equipped with a remote shut-off switch that can stop trolley, gantry, and hoist functions. The shut-off switch is to be under the control of the personnel operating the gantry crane; and
- iii)** A visible or audible indicator is to be present to alert the exposed personnel when the remote shut-off is operational.

APPENDIX 2

Maps of Route-Specific Trades (1 April 2021)

The specific trade routes in 6/3.7.3 are shown in the following table which corresponds to the Meridian Squares in BMT Global Wave Statistics. A ship assigned with the route-specific CLP-V notation is to operate in the Meridian Squares along an approved specific trade route. Operating within some specific Meridian Squares on a specific trading route shall be specifically considered with reference to the severity of the sea environment.

	<i>Route</i>	<i>Meridian Squares Along the Specific Trade Routes</i>
1	Asia – Europe	18, 28, 29, 41, 40, 62, 61, 60, 50, 37, 27, 26, 25, 16, 17, 11
2	Pacific – Atlantic	40, 41, 42, 28, 18, 19, 29, 20, 13, 14, 22, 45, 46, 55, 47, 32, 33, 23
3	North Pacific	29, 19, 20, 13, 14, 22
4	North Sea – Mediterranean	11, 17, 16, 25, 26, 27
5	North Atlantic	33, 23, 24, 15, 16, 17, 11
6	Asia – South America (West Coast)	29, 19, 20, 13, 14, 22, 46, 55, 65, 83, 95
7	South America (East Coast) – Africa	96, 87, 74, 67, 68, 84, 85, 90
8	Africa – East Asia	85, 90, 75, 76, 69, 70, 61, 62
9	Europe (Rotterdam) – Africa	17, 16, 25, 36, 35, 49, 57, 58, 68, 84, 85
10	Europe (Rotterdam) – South America (Brazil)	17, 16, 25, 35, 49, 57, 66, 74
11	US (NYC) – South America (Brazil)	23, 33, 34, 48, 56, 57, 66, 74
12	Northeast Asia - Australia	28, 40, 41, 52, 63, 71, 79, 92, 93

1 Asia – Europe

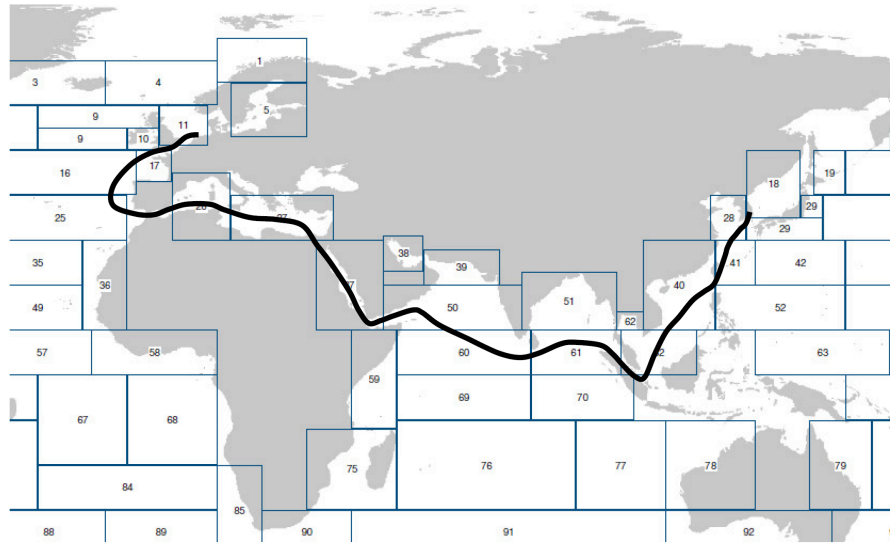

2 Pacific – Atlantic

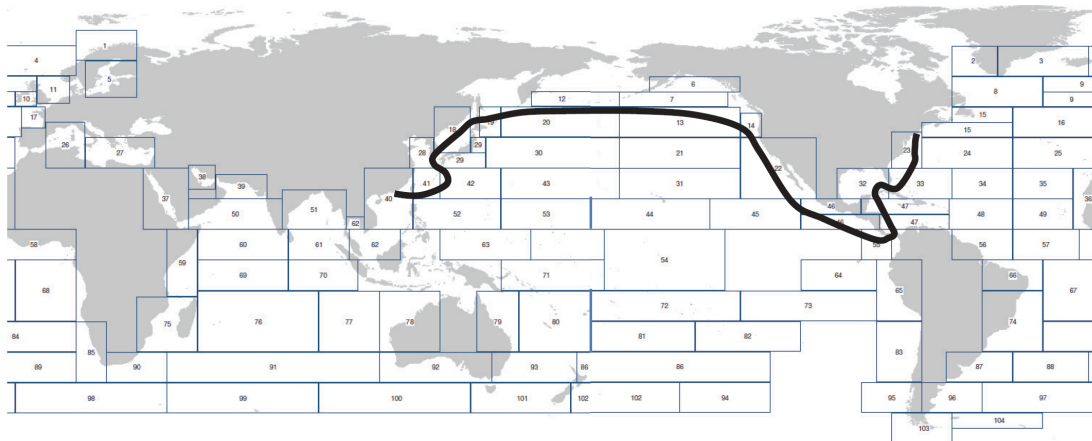

3 North Pacific

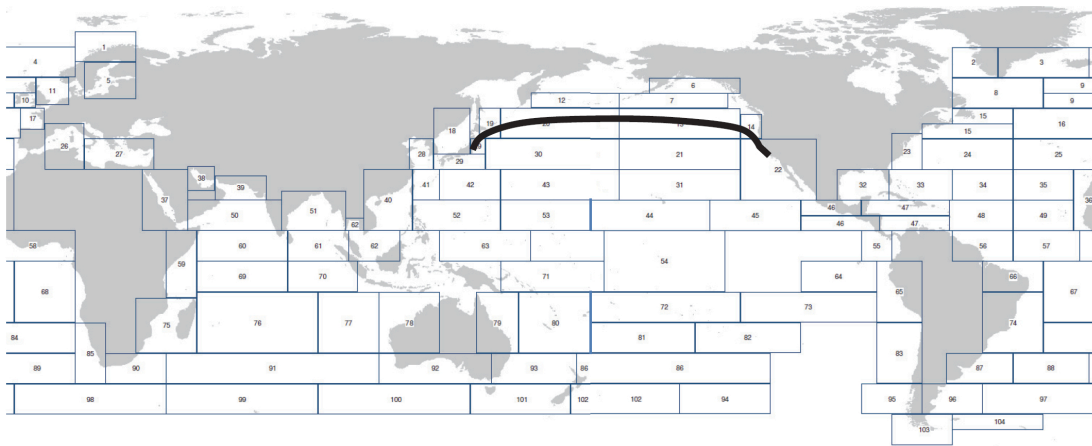

4 North Sea – Mediterranean

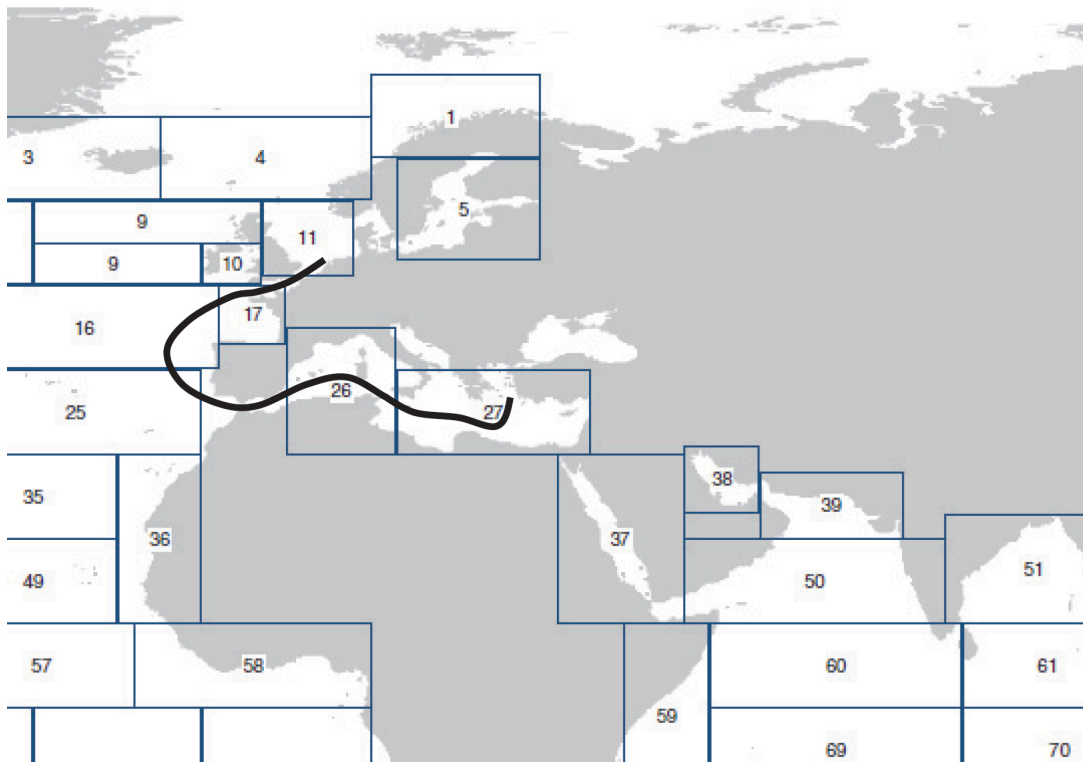

5 North Atlantic

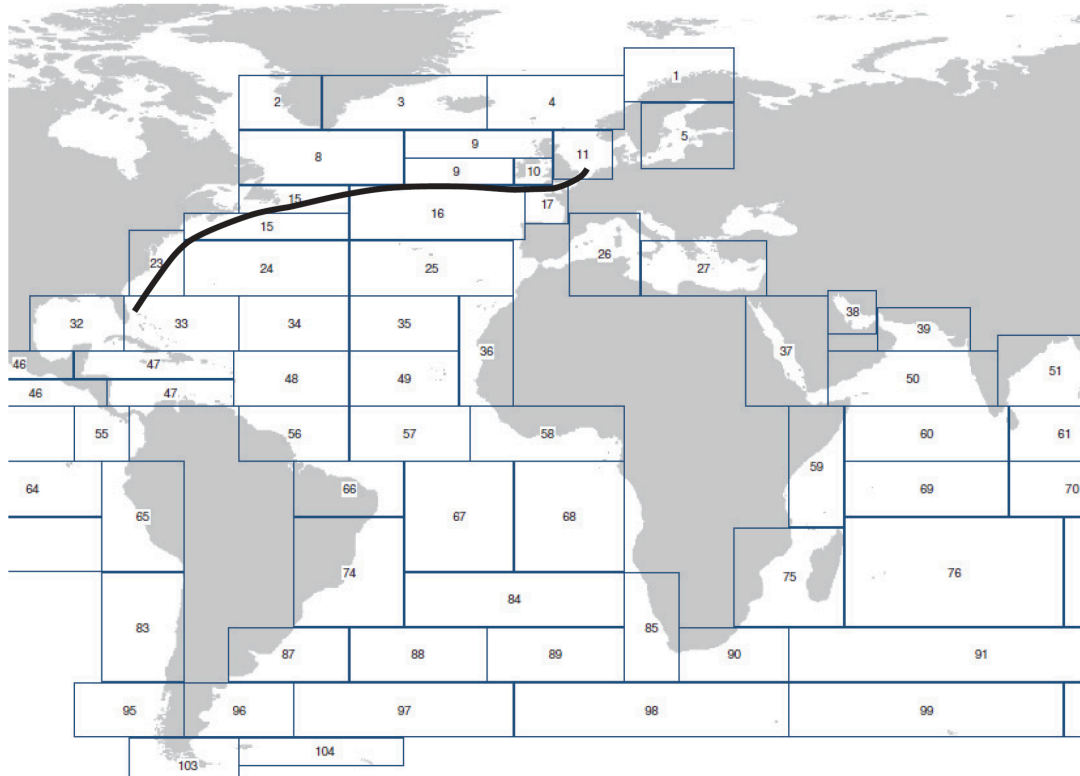

6 Asia – South America (West Coast)

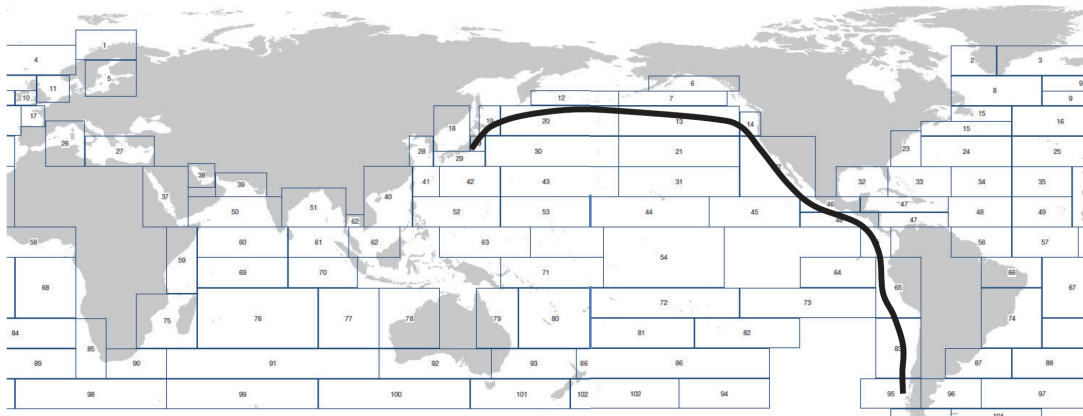

7 South America (East Coast) – Africa

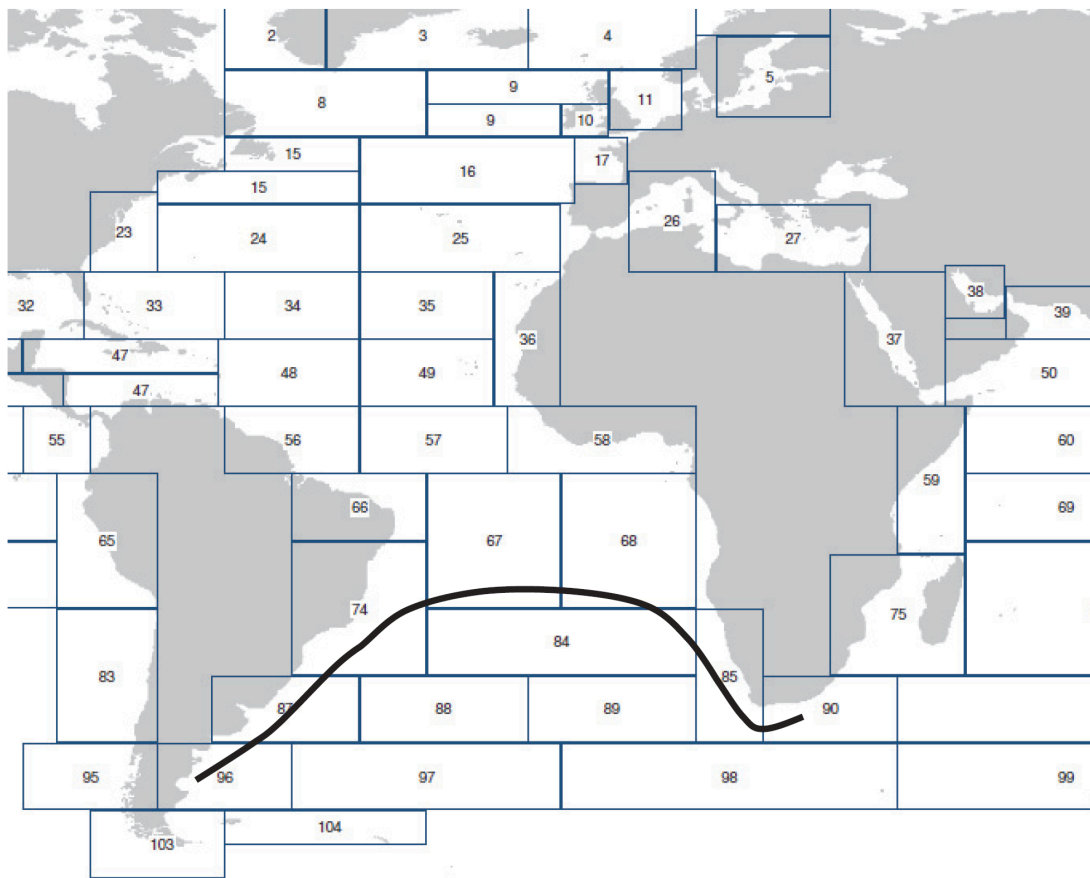

8 Africa – East Asia

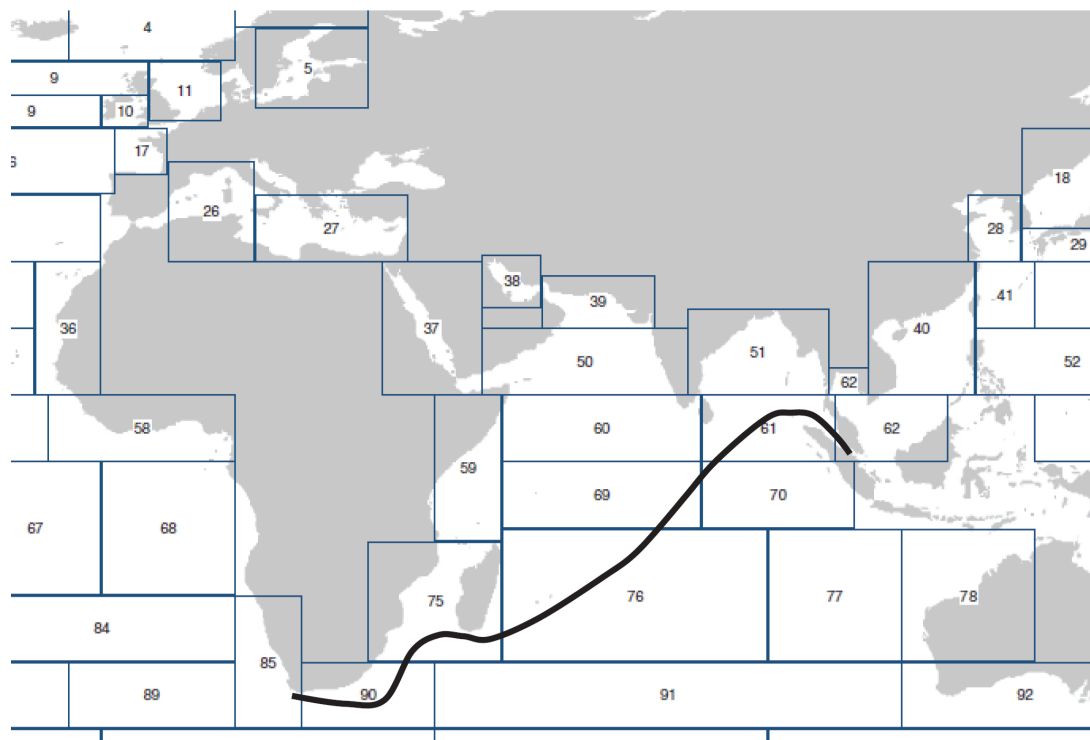

9 Europe (Rotterdam) – Africa

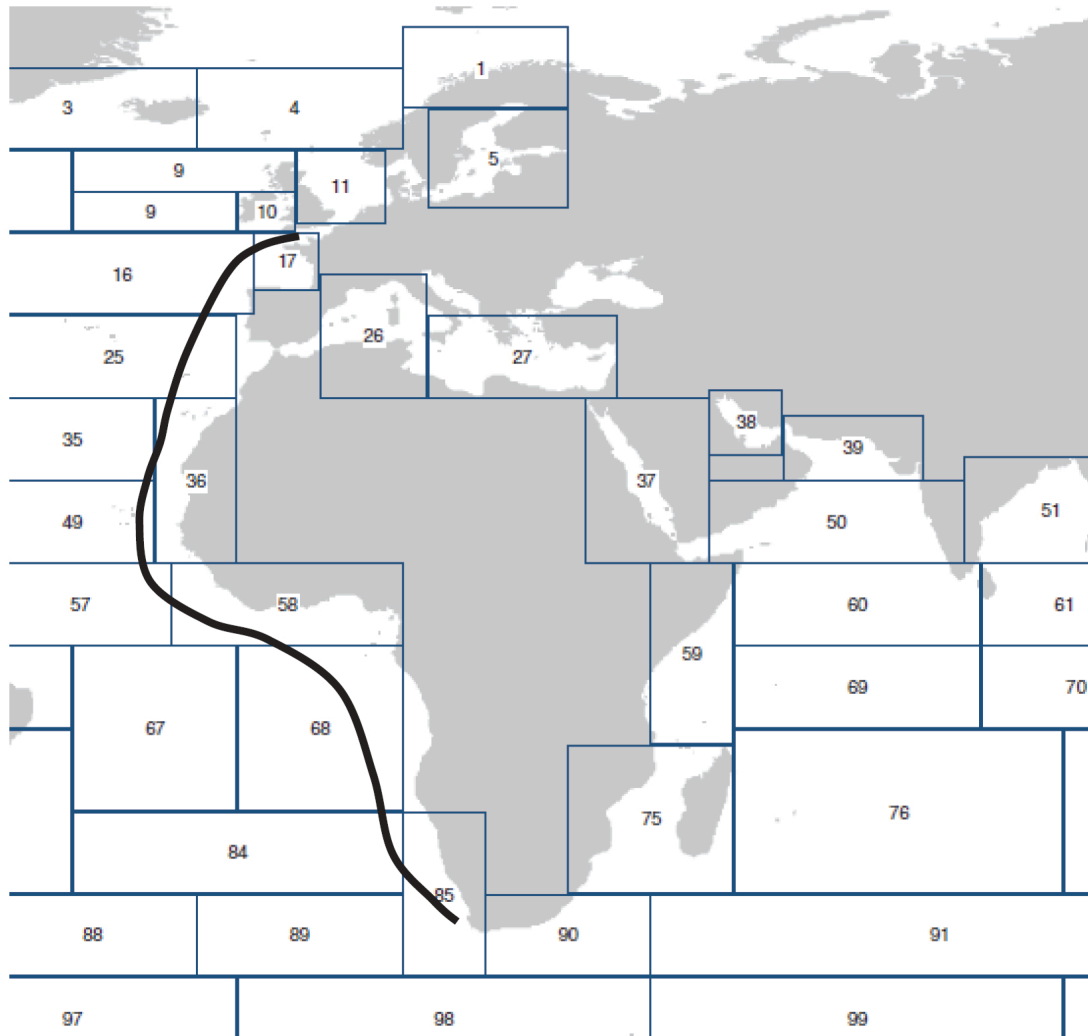

10 Europe (Rotterdam) – South America (Brazil)

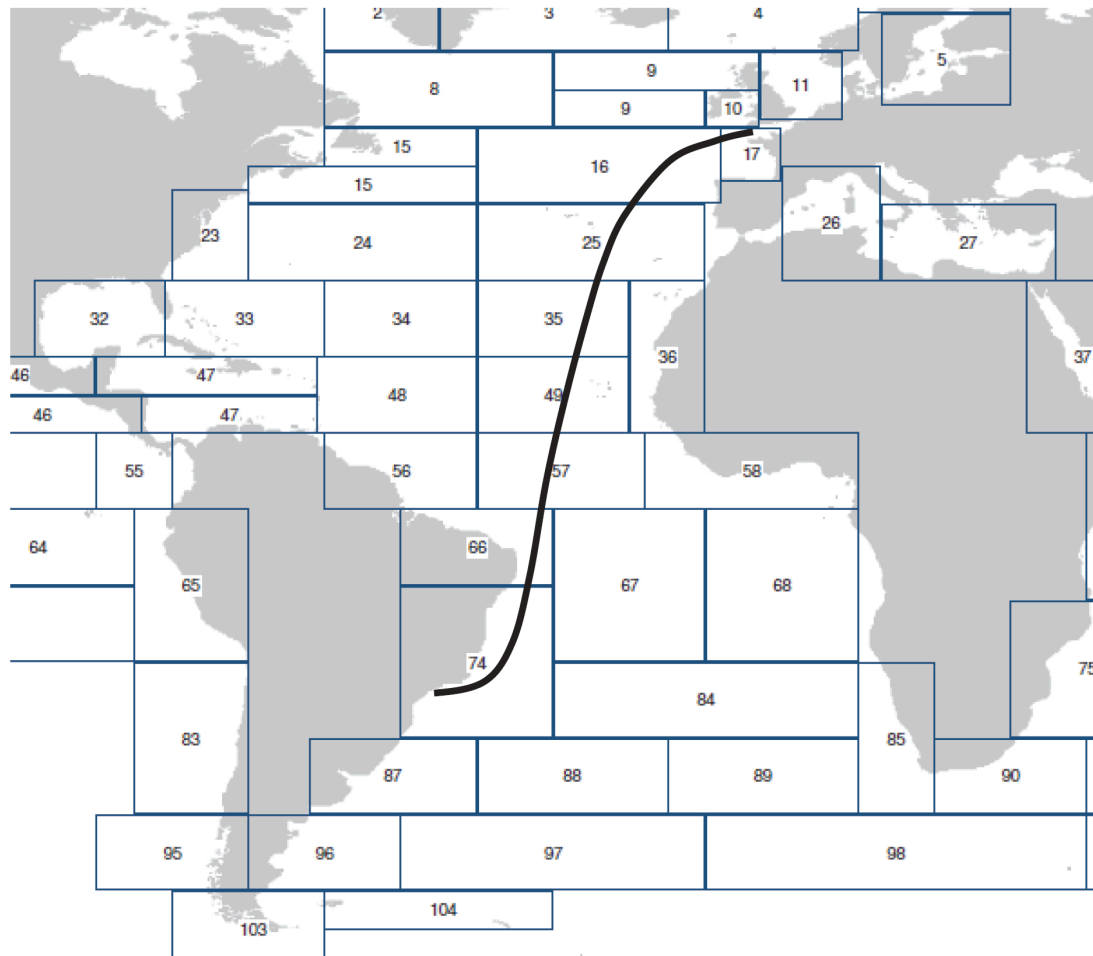

11 US (NYC) – South America (Brazil)

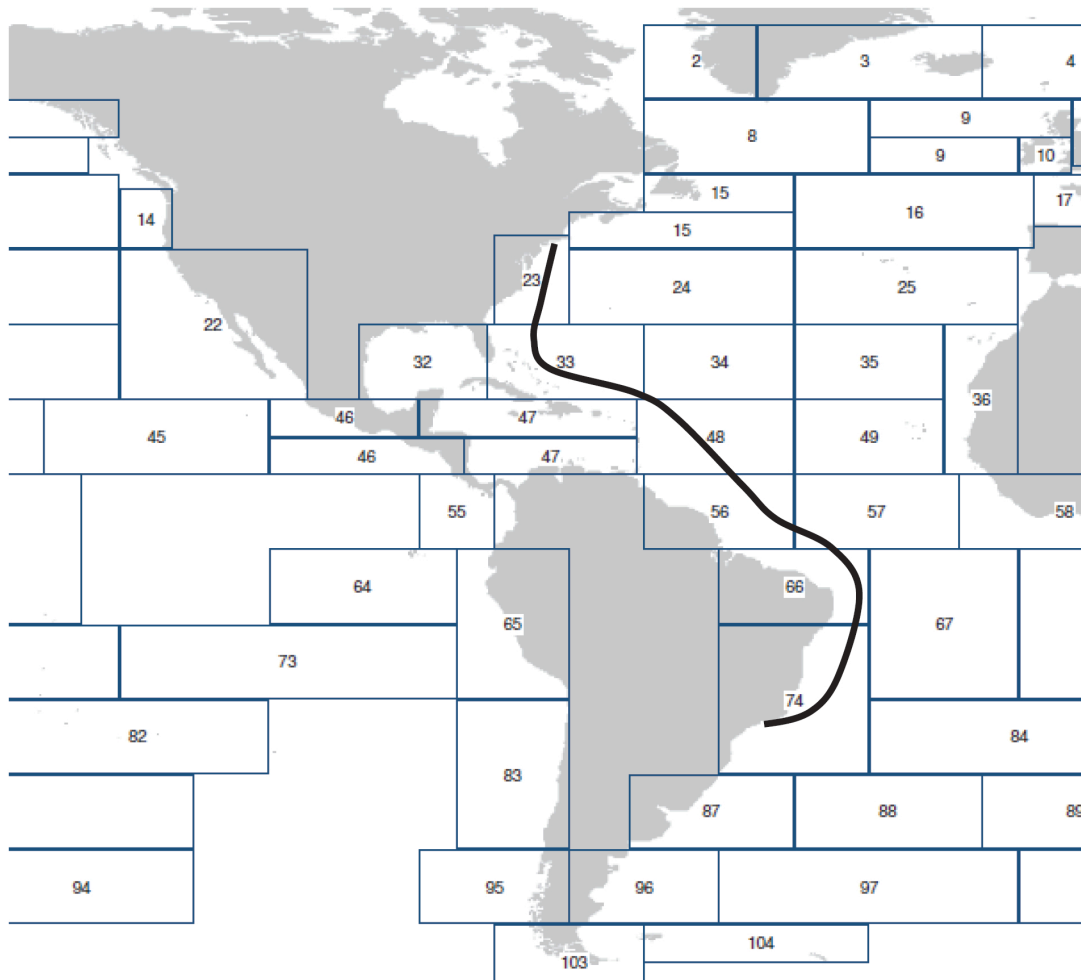

12 Northeast Asia - Australia (1 April 2021)

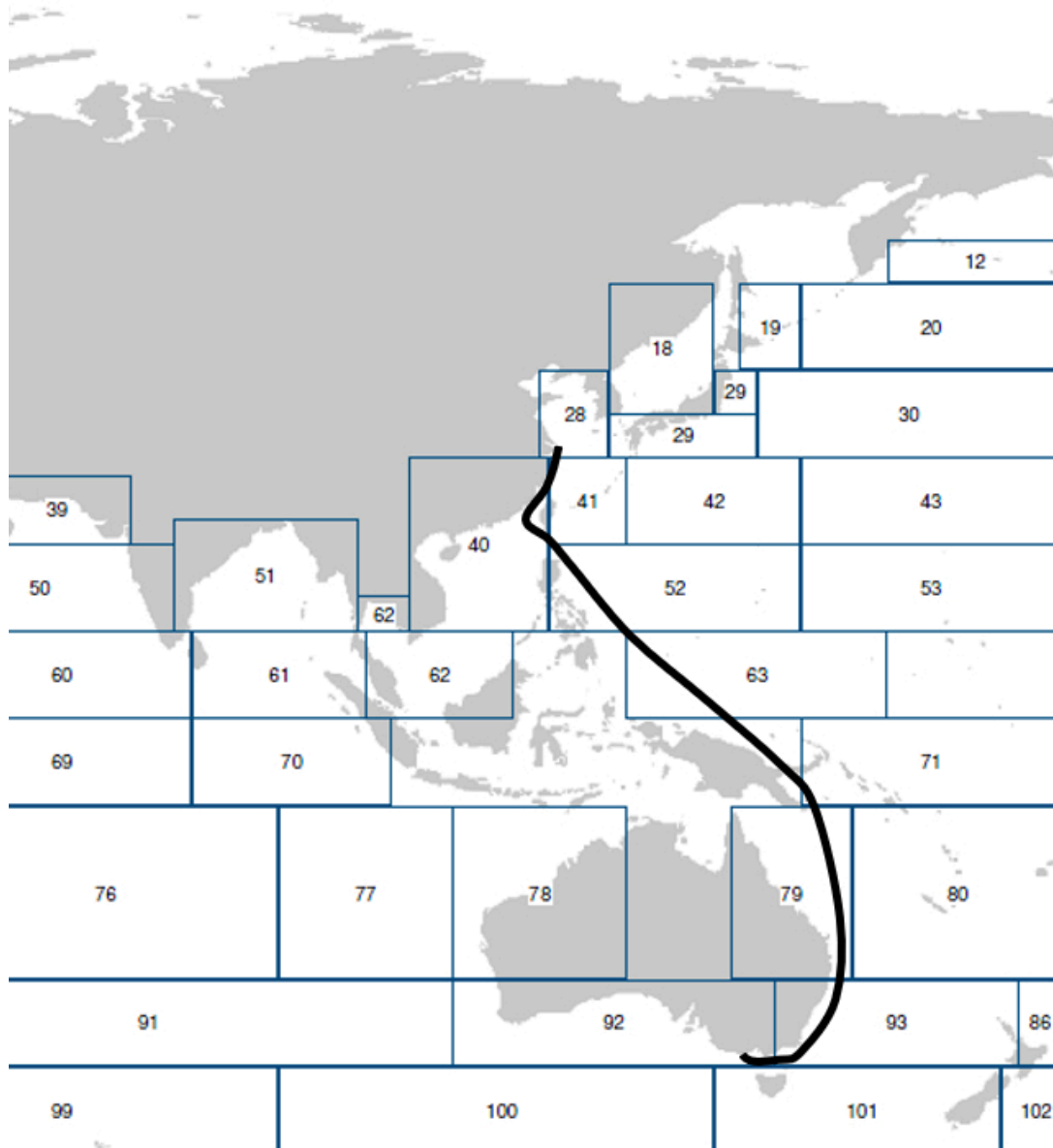

Onboard Computers for Lashing Calculations (1 April 2014)**1 General**

Container lashing calculation software is used to calculate and verify that the container securing arrangements are in compliance with the applicable strength requirements and acceptance criteria in this Guide. The software is at least to include all information and perform all calculations or checks as necessary for compliance with the applicable container securing requirements.

3 General Requirements (1 April 2021)

A user's manual is to be provided for the lashing software and kept onboard.

The onboard computer for lashing calculations is ship specific equipment and the results of the calculations are only applicable to the vessel for which it has been certified.

In case of modifications implying changes in the ship's design or container securing arrangement, the software is to be modified accordingly and re-certified.

The calculation program is to be able to calculate for any container bay whether the stowage of containers and securing arrangements are within the approval limits, and show the obtained values and the conclusions (criteria fulfilled or not fulfilled). If Condition B does not govern the stack weight limits per the information included in the Container Securing Manual according to Section 9, the calculation program only needs to address Condition A as per the analysis procedure in 6/5.

The calculation program is to include a graphical representation of the containers and lashing arrangements.

For each container arrangement the software output should indicate:

- GM value
- Roll period
- Maximum roll angle
- Container racking stiffness
- Lashing rod stiffness
- Position of each stack
- Gross container weight
- Actual stack weights
- Lashing arrangement
- Transverse, vertical and longitudinal accelerations of each container

- Lifting forces
- Lashing forces
- Transverse and longitudinal racking forces
- Corner post loads
- Pressure loads at bottom

Onshore computer calculations are acceptable provided the software used satisfies the requirements in this Appendix.

5 Plans and Data (1 April 2021)

The following documents and test cases, as a minimum, are to be submitted for review:

- i)* General description of the computer lashing program
- ii)* User's manual
- iii)* List of specific voyage trade routes with transverse acceleration reduction factor for each route, where **CLP-V** notation is assigned
- iv)* Test cases of three bays (one each from forward bay, midship bay, and aft bay) calculated for the following:
 - a)* Minimum GM and maximum GM
 - b)* Stacks of 20 ft and 40 ft containers of 8'-6" high
- v)* Test case for specific voyage trade routes, where **CLP-V** notation is assigned, calculated for the following:
 - a)* The route with the lowest "transverse acceleration reduction factor"
 - b)* Container stack in one bay selected from the locations used in item iv)
 - c)* Minimum GM
 - d)* Stacks of 20 ft and 40 ft containers of 8'-6" high
- vi)* Test cases showing unacceptable excessive results of the following:
 - a)* Stack weight
 - b)* Lashing forces
 - c)* Corner post compression
 - d)* Racking forces

Prototype Function Test Procedure for Fully Automatic Twistlocks (1 July 2016)

1 Documentation

For ABS type approval of FATs, the following information and documents are to be submitted, together with the results of the FAT function tests performed in accordance with the procedure described in this Appendix.

1.1 Design Information

i) The following design information is to be provided:

a) For FATs that rely only on the contours of their lower cone to guide, and then hold the containers in place:

Descriptions and diagrams indicating how the lower cone of the FAT will fit into the aperture of the container casting while the container is stacked on top of another by the crane. Explanation as to why the cone in its final location in the corner casting now resists upward tensile loading is also to be described by the manufacturer. The manufacturer is to fully describe how the FAT will disengage from the containers with just the use of a crane.

b) For FATs that rely on latches or turning cones which hold the containers in place:

A description of how the latch or cone of the FAT operates (i.e. latches, turns) once the cone is in its final location. The manufacturer is to fully describe how the FAT disengages from the containers with just the use of a shore-side crane.

ii) Visual or other forms of evidence are to be submitted to verify that the design of FATs provides reliably engagement with the corner castings. FATs are to be labelled to clearly identify the required orientation that it is properly inserted and engaged in the corner castings.

iii) Details of coating/corrosion protection if any

iv) Existing Service experience

v) Existing approvals (from other societies or certification bodies)

vi) Tolerances of all relevant measures of the device

vii) *Instruction Manual*. If grease or other lubricants are required for maintenance, excessive lubricant may affect the holding force of the twistlock and should be verified. A warning notice of possible reduction in holding force should be provided.

3 Test Jig Configuration

This test procedure is intended to simulate the securing effectiveness of a pair of FATs located at either end (described below as position A and position B) of containers in a stack on deck, experiencing ship's rolling and heaving while at sea.

To simulate the tipping of a container during roll and heave motion of a ship, compressive, racking and lift forces are applied to a test jig as shown in A4/3 FIGURE 1.

FIGURE 1
Test Jig (1 July 2016)

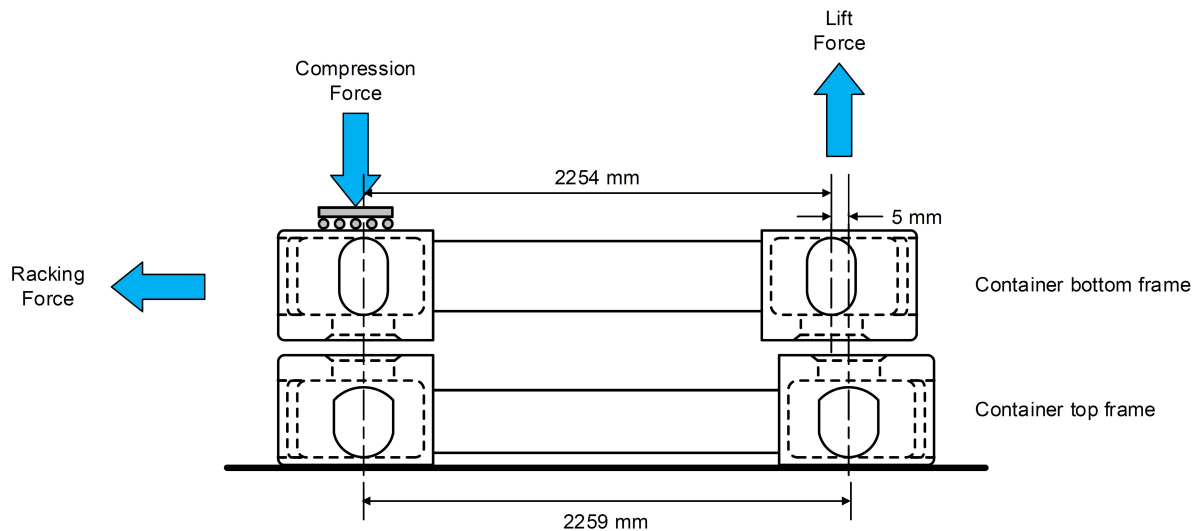

The test frame of the jig simulates an upper container bottom frame, complete with corner castings, which sits on top of a mirrored lower frame, of the lower container top frame with corner castings.

The distance between centers of corner casting apertures of the upper test frame is 5 mm (0.2 in.) less than the ISO 1496-1 standard 2259 mm (89 in.) distance between centers of corner casting apertures of the lower test frame. The 5 mm (0.2 in.) offset represents the ISO allowable container frame width tolerance.

As shown in the above figure, the tension side of the test jig is misaligned such that the racking force increases the misalignment. Consideration is also to be given to the case where the misalignment is in the opposite direction, where the distance between centers of the corner casting apertures of the upper test frame is the ISO standard distance and the lower test frame is 5 (0.2) mm (in.) less, in case it is a more severe condition. Although the test jig shows the two upper and lower pairs of corner castings each connected by a stiff horizontal beam, the lower corner castings need not be connected by a beam if they are instead firmly mounted on a test bed.

5 Corner Castings

A separate series of tests are to be performed using ISO 1161 corner castings and also reduced corner castings that have been machined to a reduced plate thickness containing the top aperture to simulate worn castings. The ISO corner castings are to be manufactured from the same material used for mass container production and sourced from a supplier to the container supporting industry. The ISO corner castings are to have top aperture minimum widths of 65 mm (2.56 in.), which includes an IMO maximum tolerance of 1.5 mm (0.06 in.) above the standard aperture width of 63.5 mm (2.50 in.), as shown in A4/5 FIGURE 2. The reduced (worn) corner castings are to have the thickness of the plate containing the top aperture reduced to 26 mm (1.0 in.) with aperture width increased from 65 mm (2.56 in.) to 66 (2.60 in.). These are limiting values determined from the IMO International Convention for Safe Containers 1972 (CSC), CSC.1/

Circ.138/Rev.1, 5 August 2013 in which the corner castings can no longer be used with FATs to transport containers at sea.

During testing the upper and lower corner castings are connected by FATs. Hydraulic cylinders are normally used to apply the forces on the corner castings as shown. A roller plate is shown in A4/3 FIGURE 1 to prevent any horizontal friction between the contact surfaces of the apparatus applying the compressive force and the corner casting, when racking force is applied.

FIGURE 2
ISO Corner Casting (1 July 2016)

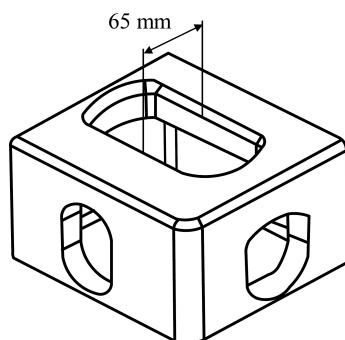

Alternative test apparatuses proposed by FAT manufacturer may be considered.

7 Prototype Load Test

7.1 Position A and B

During ship's rolling and heaving in a seaway the twistlocks on the port and starboard sides of a container in a stack experience both compression and tension (lift) forces, depending on direction of roll.

The geometry of the lower cone of the FAT is generally not symmetric about its vertical axis. When lift force is applied the contact surfaces between the twistlock lower cone with the top plate underside of the lower corner casting will be different whether rolling to port or starboard. It is necessary therefore that the twistlocks be tested to simulate the forces when rolling to port and starboard. A4, Figure 3(a) illustrates these motions and forces.

In the test jig, the lift force is applied at the same twistlock location for all tests as shown in A4/3 FIGURE 1. The twistlocks are positioned facing forward, and then facing aft, to represent position A and position B, as shown in A4, Figure 3(b).

FIGURE 3
Container Movement and Forces Position A and B (1 July 2016)

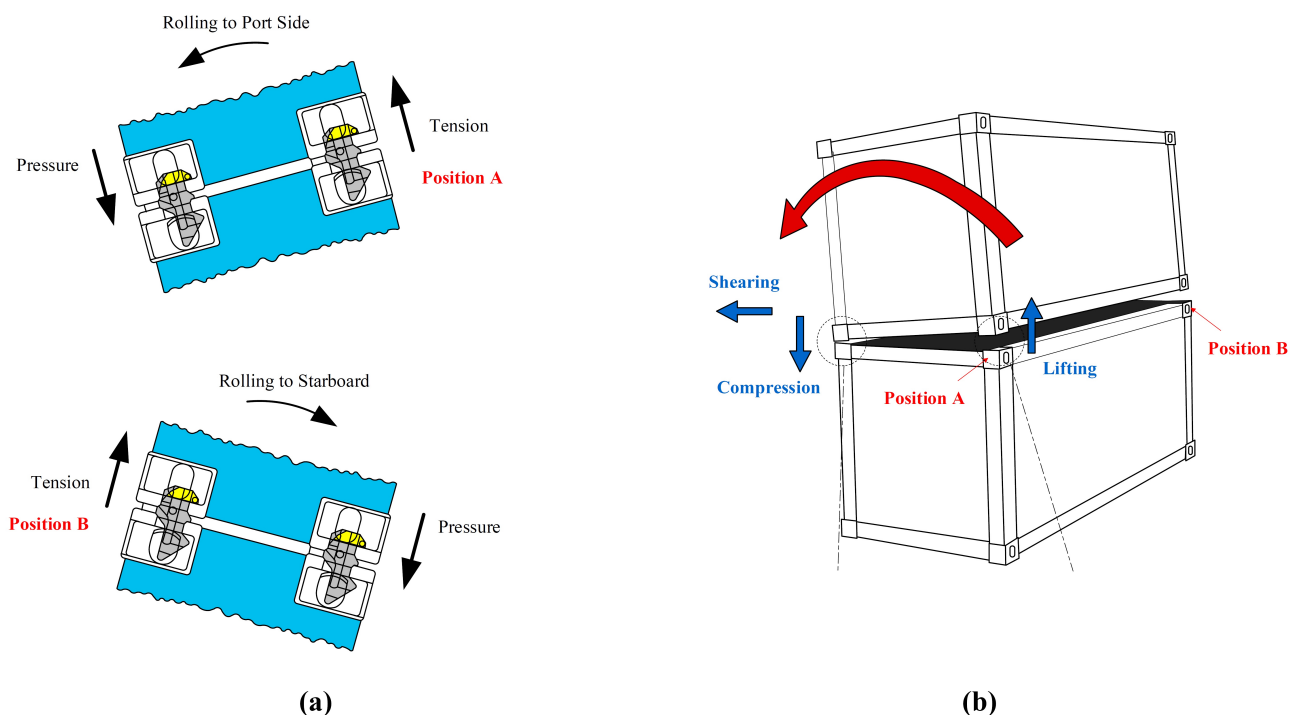

7.3 Loads and Their Sequences

The loads are to be applied in the sequence listed in Appendices A4/7.3.1 or A4/7.3.2, as the case may be. At each stage the previously applied force is to be kept constant.

7.3.1 New ISO Corner Castings

The following loads are to be applied in the order of Step 1 through Step 9:

- i)* Compressive force 350 kN (35.1 Ltf)
- ii)* Racking force 150 kN (15 Ltf)
- iii)* Lift force 275 kN (27.6 Ltf) ($1.1 \times \text{SWL}$, where $\text{SWL} = 250 \text{ kN}$ (25.1 Ltf))

- Step 1 Record vertical separation distance between upper and lower corner castings in the tension side of the test jig.
- Step 2 Apply compressive force of 350 kN. (35.1 Ltf)
- Step 3 Apply racking force of 150 kN. (15 Ltf)
- Step 4 Apply small lift force so as to take up any twistlock clearance without load so that twistlock engages.
- Step 5 Record vertical separation distance between upper and lower corner castings in the tension side of the test jig.
- Step 6 Continue to apply lift force to 250 kN (25.1 Ltf) and hold for 2 minutes.
- Step 7 Record vertical separation distance between upper and lower corner castings in the tension side of the test jig.
- Step 8 Continue to apply lift force to 275 kN, (27.6 Ltf) and hold for 2 minutes.
- Step 9 Record vertical separation distance between upper and lower corner castings in the tension side of the test jig during 2 minute holding period.

The twistlock vertical clearance without load, Step 5 minus Step 1 vertical separation distance, and the twistlock vertical clearances at 250 kN (25.1 Ltf) and 275 kN (27.6 Ltf) lift force, (Step 7 minus Step 1 and Step 9 minus Step 1, respectively) vertical separation distances, are to be submitted to ABS.

- Three twistlock samples, each twistlock oriented in position A is to be lifted three times to 275 kN,(27.6 Ltf) and similarly in position B.
- On the third lift of each tested FAT to 275 kN (27.6 Ltf) in both positions A and B, the lift force is to be increased up to the design minimum breaking load of the twistlock or until the twistlock pulls out from the corner casting, whichever occurs first. It is to be shown that an operational margin exists between the stated SWL and the resulting breaking/pull out force. The pull out force is to be recorded and submitted to ABS for reference.
- For each twistlock tested, a new corner casting is to be used when tested in positions A and B.

Inspection

- Twistlocks are to be removed after each series of load tests (Step 1 to Step 9) and corner castings are to be inspected. No damage to the twistlock or any deformation of the corner casting is allowed beyond 3 (0.12) mm (in.) from its original plane

7.3.2 Reduced ISO Corner Castings

The following loads are to be applied in the order of Step 1 through Step 9:

- i)* Compressive force 350 kN (35.1 Ltf)
- ii)* Racking force 150 kN (15 Ltf)
- iii)* Lift force 275 kN (27.6 Ltf) ($1.1 \times \text{SWL}$, where $\text{SWL} = 250 \text{ kN (25.1 Ltf)}$)

- | | |
|--------|---|
| Step 1 | Record vertical separation distance between upper and lower corner castings in the tension side of the test jig. |
| Step 2 | Apply compressive force of 350 kN. (35.1 Ltf) |
| Step 3 | Apply racking force of 150 kN. (15 Ltf) |
| Step 4 | Apply small lift force so as to take up any twistlock clearance without load so that twistlock engages. |
| Step 5 | Record vertical separation distance between upper and lower corner castings in the tension side of the test jig. |
| Step 6 | Continue to apply lift force to 250 kN (25.1 Ltf) and hold for 2 minutes. |
| Step 7 | Record vertical separation distance between upper and lower corner castings in the tension side of the test jig. |
| Step 8 | Continue to apply lift force to 275 kN, (27.6 Ltf) and hold for 2 minutes. |
| Step 9 | Record vertical separation distance between upper and lower corner castings in the tension side of the test jig during 2 minute holding period. |

The twistlock vertical clearance without load, Step 5 minus Step 1 vertical separation distance, and the twistlock vertical clearances at 250 kN (25.1 Ltf) and 275 kN (27.6 Ltf) lift force, (Step 7 minus Step 1 and Step 9 minus Step 1, respectively) vertical separation distances, are to be submitted to ABS.

- Three twistlock samples, each twistlock oriented in position A is to be lifted three times to 275 kN,(27.6 Ltf) and similarly in position B.
- On the third lift of each tested FAT to 275 kN (27.6 Ltf) in both positions A and B, the lift force is to be increased up to the design minimum breaking load of the twistlock or until the

twistlock pulls out from the corner casting, whichever occurs first. It is to be shown that an operational margin exists between the stated SWL and the resulting breaking/pull out force. The pull out force is to be recorded and submitted to ABS for reference.

- For each twistlock tested, a new reduced corner casting is to be used when tested in positions A and B.

Inspection

- Twistlocks are to be removed after each series of load tests (Step 1 to Step 9) and corner castings are to be inspected. No damage to the twistlock or any deformation of the corner casting is allowed beyond 3 (0.12) mm (in.) from its original plane.

Testing is also to be performed to demonstrate that the FAT will release as designed when an onboard container is lifted by a shore-side crane. In addition, the manufacturer is to demonstrate that when the top container in a stack is lifted, the FATs securing the container one tier further down the stack do not release.

For novel FATs, sea trial tests of the FATs in actual operations on trading containerships may be required.

7.3.3 Determination of Vertical Clearance at SWL to be Used in Lashing Calculations

(1 August 2024)

The twistlock vertical clearance, referenced in the container securing system analysis in Subsection 6/5, is to be derived from the function test results in A4/7.3.1 or A4/7.3.2, which are summarized in Appendix 4, Table 1.

TABLE 1
Vertical Clearance for Lashing Calculation

Case	Sample Number	Vertical Clearance at SWL (Step 7 minus Step 1)
Case 1 Position A, new castings	1	Vertical Clearance 1: to be taken as the average value of Sample 1 to 3
	2	
	3	
Case 2 Position B, new castings	4	Vertical Clearance 2: to be taken as the average value of Sample 4 to 6
	5	
	6	
Case 3 Position A, reduced castings	7	Vertical Clearance 3: to be taken as the average value of Sample 7 to 9
	8	
	9	
Case 4 Position B, reduced castings	10	Vertical Clearance 4: to be taken as the average value of Sample 10 to 12
	11	
	12	

The vertical clearance at SWL to be used in lashing calculations is the average of maximum value with new and reduced castings, respectively, i.e.:

$$\{\text{Max (Vertical Clearance 1, Vertical Clearance 2)} + \text{Max (Vertical Clearance 3, Vertical Clearance 4)}\}/2$$

APPENDIX 5 References (1 July 2016)

The following common international standards are applicable to containers and container securing systems. Their requirements are not duplicated in this Guide, but included by reference where appropriate.

- 1) ISO 1496-1:1990, Series 1 Freight Containers, Specification and Testing, Part 1 General Cargo Containers for General Purposes
- 2) ISO 668:1995, Series 1 Freight Containers, Classification, Dimensions and Ratings, as amended 2005(E)
- 3) ISO 1161:1984, Series 1 Freight Containers, Corner Fittings Specification
- 4) ISO standard 9711-1:1990, Information Related to Containers on Board Vessels, Part 1, Bay Plan System
- 5) IMO International Convention for Safe Containers (CSC), 1972, as amended
- 6) IMO International Convention for the Safety of Life at Sea (SOLAS) 1974, Chapters VI and VII, as amended
- 7) IMO 2003 Edition of Code of Safe Practice for Cargo Stowage and Securing
- 8) IMO MSC/Circ 745, Guidelines for the Preparation of the Cargo Securing Manual
- 9) IACS Recommendation 63, General Cargo Containers: Prototype Test Procedures and Test Measurements
- 10) ISO 3874:2015(E), Series 1 Freight Containers – Handling and Securing